

Features

- ◆ Pb free product—RoHS compliant
- ◆ Low power consumption, High efficiency
- ◆ Reliable and rugged
- ◆ High luminous intensity
- ◆ Long life – solid state reliability
- ◆ Viewing angle: 120°(R/G/B)

Package Dimension

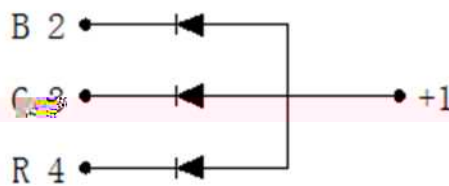
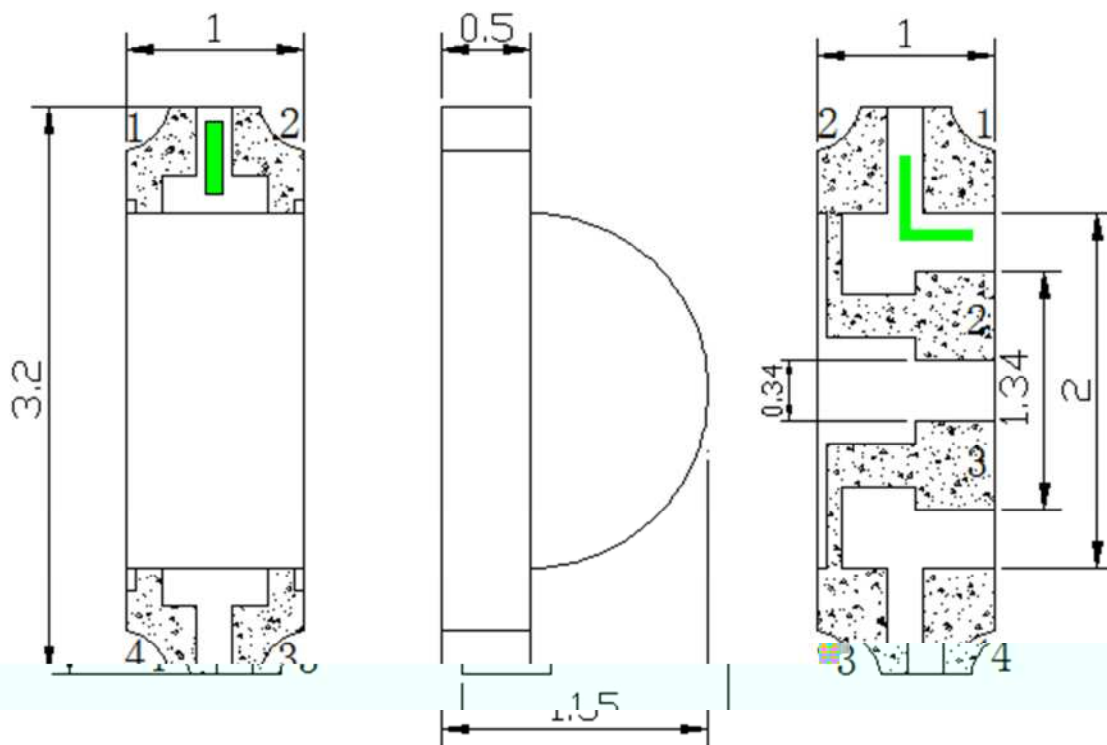

| Part No. | Lens Color | Source Color |
|----------------------|-------------|----------------|
| SL-T3210RGBC020-L150 | Water Clear | Red/Green/Blue |

Notes:

1. All dimensions are in millimeters.
2. Tolerance is $\pm 0.10\text{mm}$ unless otherwise noted.
3. Specifications are subject to change without notice.



| Parameter | Red | Green | Blue | Unit |
|--|-------------|-------|------|------|
| Power Dissipation | 55 | 80 | 80 | mW |
| Peak Forward Current ^{*2} | 60 | 60 | 60 | mA |
| Continuous Forward Current | 25 | 25 | 25 | mA |
| Reverse Voltage | 5 | 5 | 5 | V |
| Moisture Sensitivity Level ^{*1} | 4 | | | |
| Operating Temperature Range | -40 to + 85 | | | |

LIGHT

LIGHT ELECTRONICS CO., LTD.



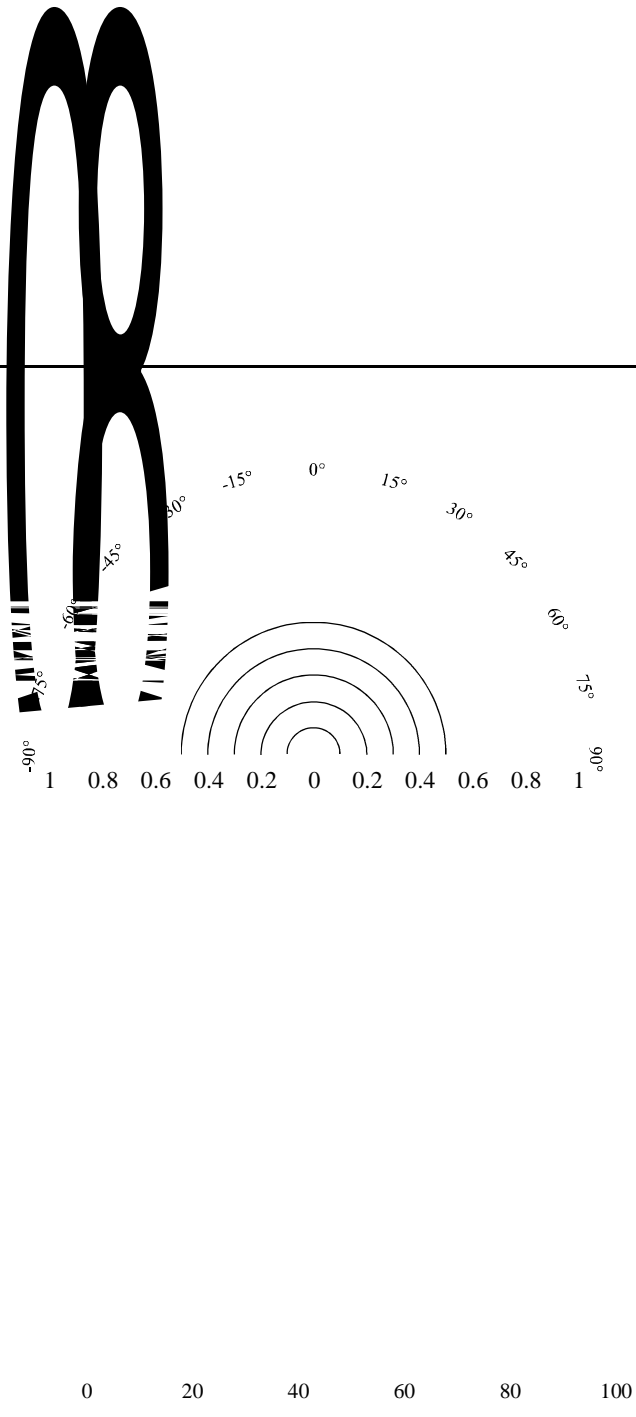

°C





Label Explanation

LIGHT Universal Label

| | |
|---|--|
| LIGHT Light Electronics CO., LTD. |  |
| MODEL NAME: _____ |  LOT NO. : _____ |
| QUANTITY: _____ | |
| BIN: _____ | |
| PACKING DATE: _____ | |
| REMARKS: _____ | |

Customer Defined Label

| | |
|---|--|
| LIGHT Light Electronics CO., LTD. |  |
| MODEL NAME: _____ |  LOT NO. : _____ |
| QUANTITY: _____ | |
| BIN: _____ | |
| PACKING DATE: _____ | |
| CUSTOMER P/N: _____ | |

Reel Dimensions

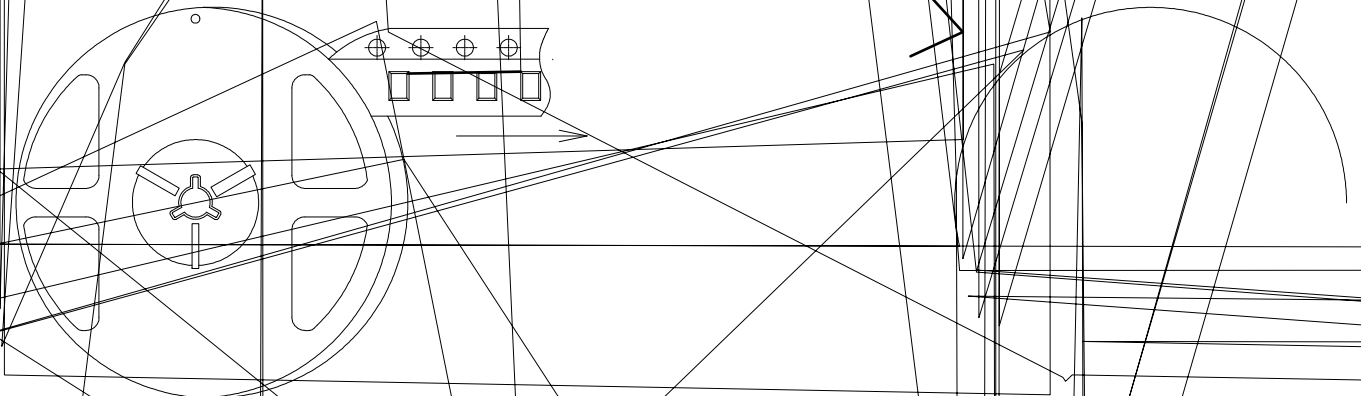

Tolerance unless mentioned is $\pm 0.2\text{mm}$; Unit = mm

Carrier Tape Specifications (Loaded Quantity: 3000pcs/reel)

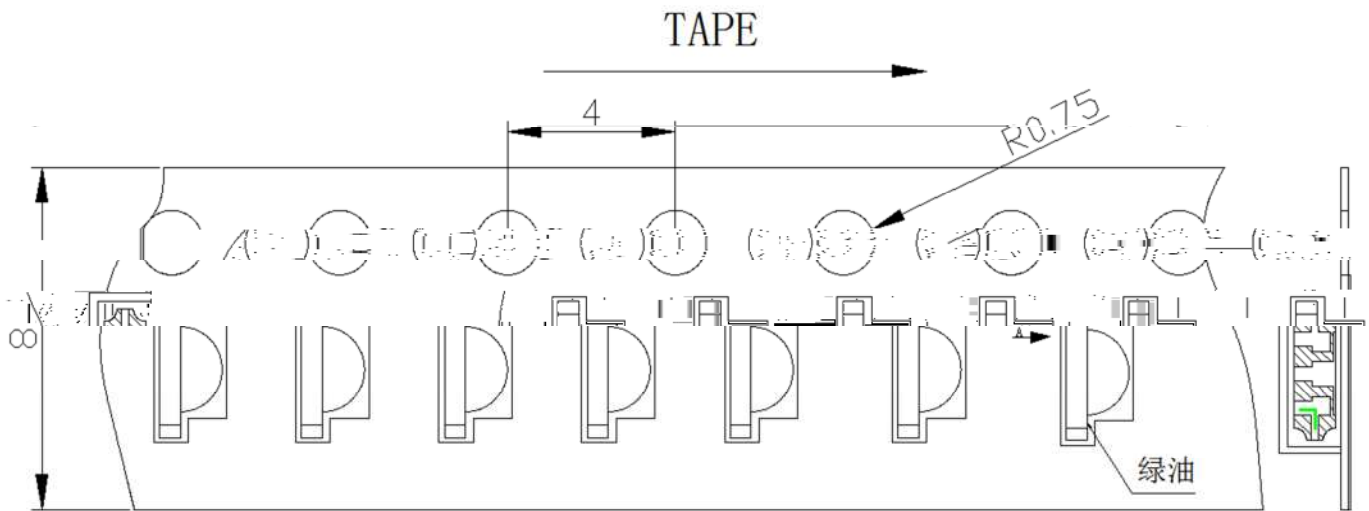

Moisture Resistant Packaging

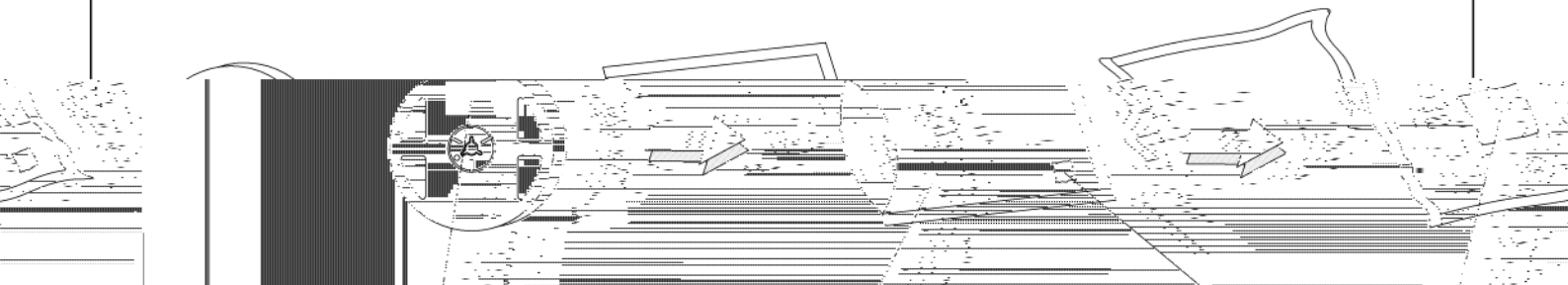

LIGHT universal Label

Aluminum moisture-proof bag

Desiccant

Customer defined Label or LIGHT universal Label

Suggest IR Reflow Condition For Lead Free

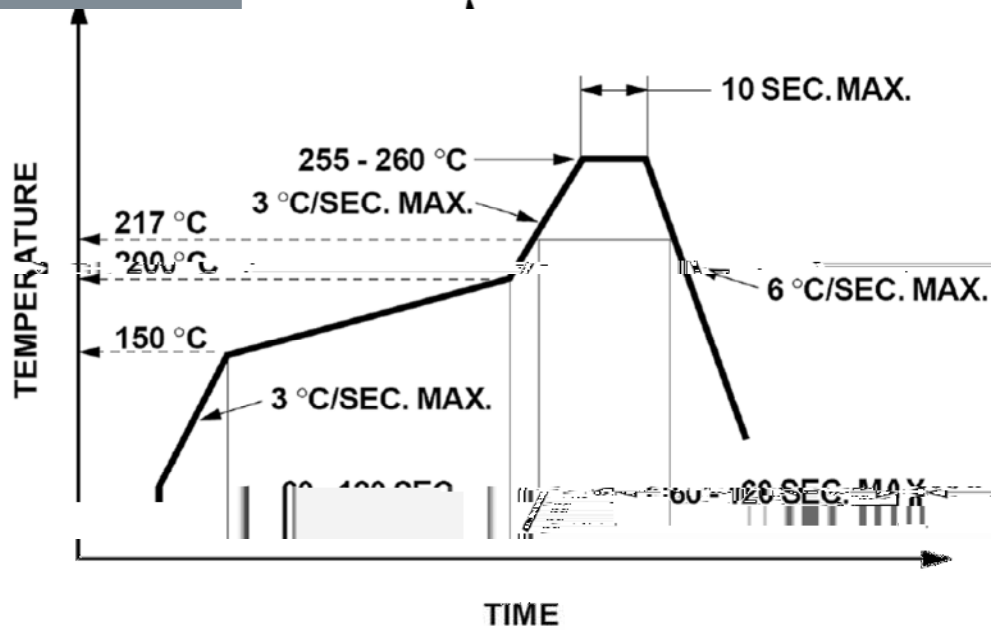

1. Reflow soldering should not be done more than two times.
2. When soldering, do not put stress on the LEDs during heating.

Soldering iron

1. When hand soldering, the temperature of the iron must less than 300 °C for 3 seconds.
2. The hand solder should be done only once.

Repairing

Repair should not be done after the LEDs have been soldered. When repairing is unavoidable, a double-head soldering iron should be used (as below figure). It should be confirmed beforehand whether the characteristics of LEDs will or will not be damaged by repairing.

