

LIGHT

LG-5

SPEC. NO. : SZ
 DATE : 20210
 REV : A/32/13
 2

Approved By: 

Version

RI	
A/0	Pin and PCB surface improvement
A/1	Pin and PCB surface improvement
A/2	In order to improve the product at the client's request, the technical specifications were modified from 0.05mm to 0.03mm.
A/3	

Part No. LG-05IR4D940

Absolute Maximum Ratings at Ta=25°C

Parameter	MAX.	Unit
Power Dissipation	200	mW
Continuous Forward Current	100	mA
Peak Forward Current*3	200	mA
Reverse Voltage	5	V
Operating Temperature	-40 to + 85	
Storage Temperature	-40 to + 100	
IR Reflow Temperature	245 for 30 seconds	

1. Storage

The storage ambient for the LEDs should not exceed 30°C temperature or 70% relative humidity.

It is recommended that LEDs out of their original packaging are used within three months.

For extended storage out of their original packaging, it is recommended that the LEDs be stored in a sealed container with appropriate desiccant or in desiccators with nitrogen ambient.

2. Precautions in handling:

- When soldering, leave 2mm of minimum clearance from the resin to the soldering point.
- Dipping the resin to solder must be avoided.
- Correcting the soldered position after soldering must be avoided.
- In soldering, do not apply any stress to the lead frame particularly when heated.
- When forming a lead, make sure not to apply any stress inside the resin.
- Lead forming must be done before soldering.
- It is necessary to cut the lead frame at normal temperature.

3. Peak Forward Current:

Condition for is IFP pulse : At 1ms cycle, 50% duty, emitting 32kHz square wave signal.

4. Caution in ESD:

Static Electricity and surge damages the LED. It is recommend to use a wrist band or anti-electrostatic glove when handling the LED. All devices, equipment and machinery must be properly grounded.

Electrical Optical Characteristics at Ta=25°C

Parameter	Symbol	Min.	Typ.	Max.	Unit	Test Condition
Radiant Intensity	Ie	40	56	78	mW/sr	I

Infrared Emitting Diode Specification

- Commodity: Infrared emitting diode
- Intensity Bin Limits (At 50mA)

BIN CODE	Min.(mW/sr)	Max.(mW/sr)
16	40	56
17	56	78

Note: The Ie guarantee should be added $\pm 15\%$ tolerance.

Suggest IR Reflow Condition For Lead Free:

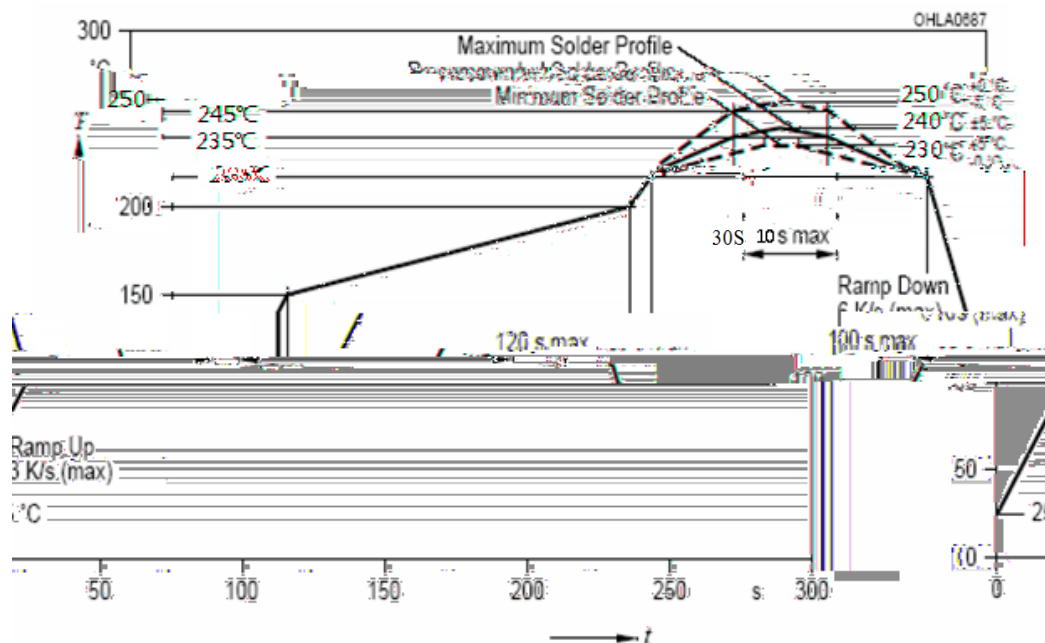

Typical Electrical / Optical Characteristics Curves (25°C Ambient Temperature Unless Otherwise Noted)

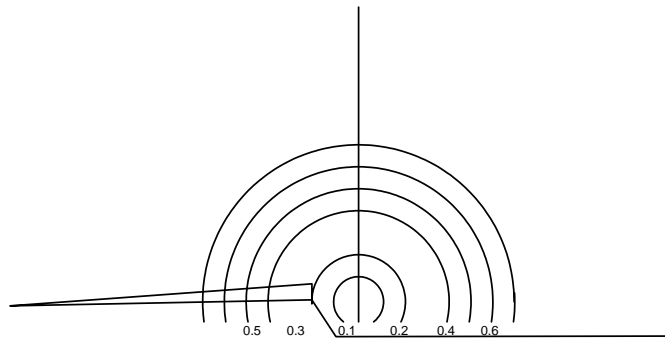
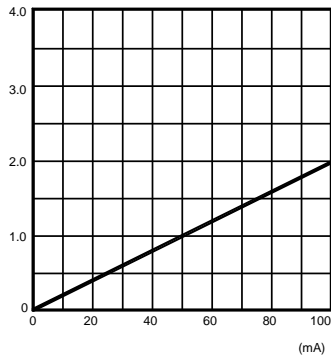
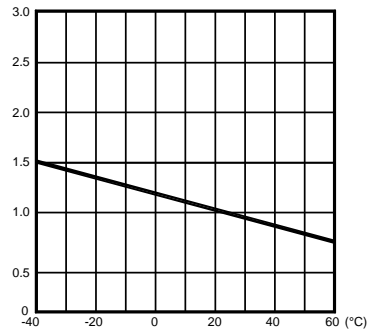
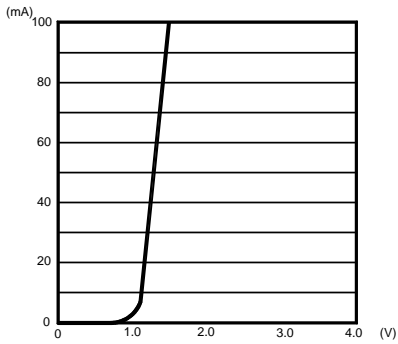
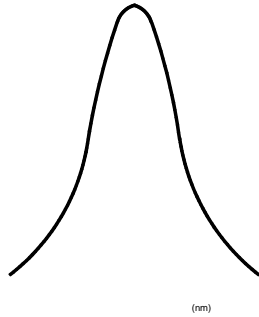

Package

Package Dimensions

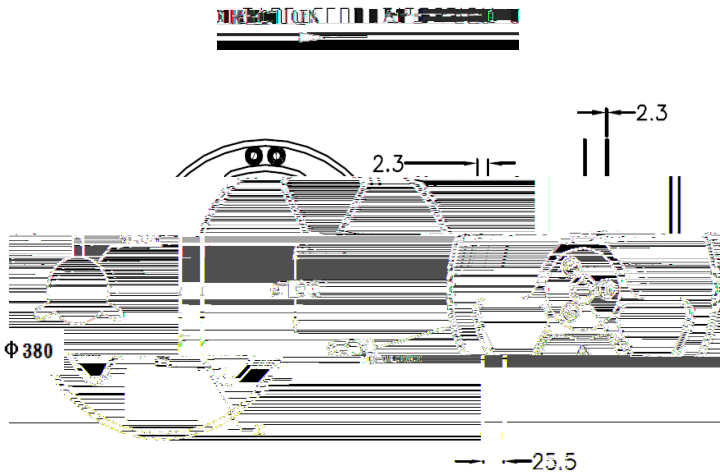
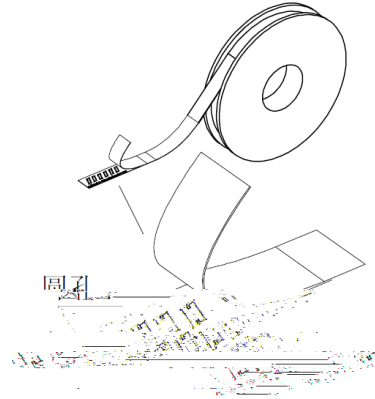
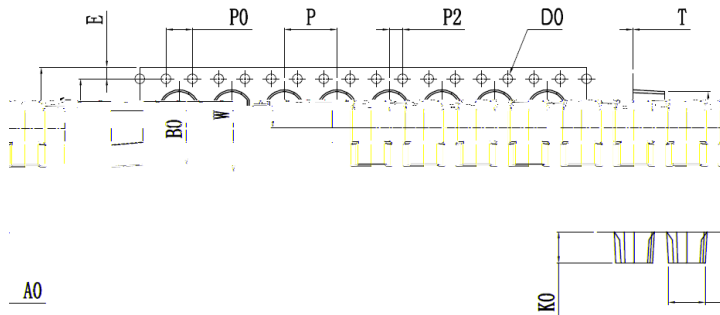

Item	Specification	
	Minum	Maximum
W	15.97	16.3
P	7.9	8.1
E	1.65	1.85
F	7.4	7.6
D	1.5	1.6
P0	3.9	4.1
P0x10	39.8	40.2
P2	1.9	2.1
AO	5.2	5.4
BO	10.6	10.8
KO	4.8	5.0

Notes:

- 1.All dimensions in millimeters.
- 2.All dimensions meet EIA-481-C requirements.
- 3.Cover tape by a heat sealing manner.

