

SL-T2528RGBIC-L110

DATA SHEET

SPEC.NO. : SZ18092602
DATE : 2018/09/26
REV. : A/0

Approved By:

Checked By:

Prepared By:



% '

& '

' '

(..... ('

) F..... " " " "

LIGHT ELECTRONICS CO., LTD.

*" D] b Zi bVh] cb

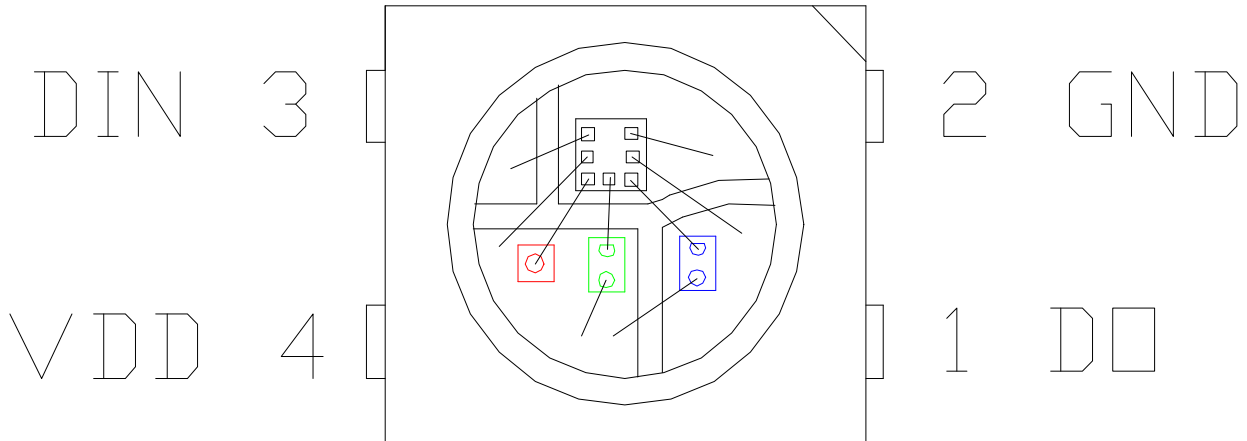

%	8C		
&	; B8		
'	8=B		
(J88		D76

+ " 9` YVhfc! cdh] WU` VXUFUVhYf] gh] Vg Uh HU1&) F; 6

=hYa	GraVc`	A]I	Hrd	AUI	I b] h	7cbX] h] cbg
8ca] bUbh kUj Y` Yb[h\	E` X	;)&\$)&)	ba	=: 1%&a5
		F *&\$		*&)		
		6 (*)		(+\$		
@ a] bci g] bhYbg] hm	=J	; , \$\$		%&\$\$	aVK	=: 1%&a5
		F &\$\$		(\$\$		
		6 % \$		' \$\$		

L

LIGHT ELECTRONICS CO., LTD.

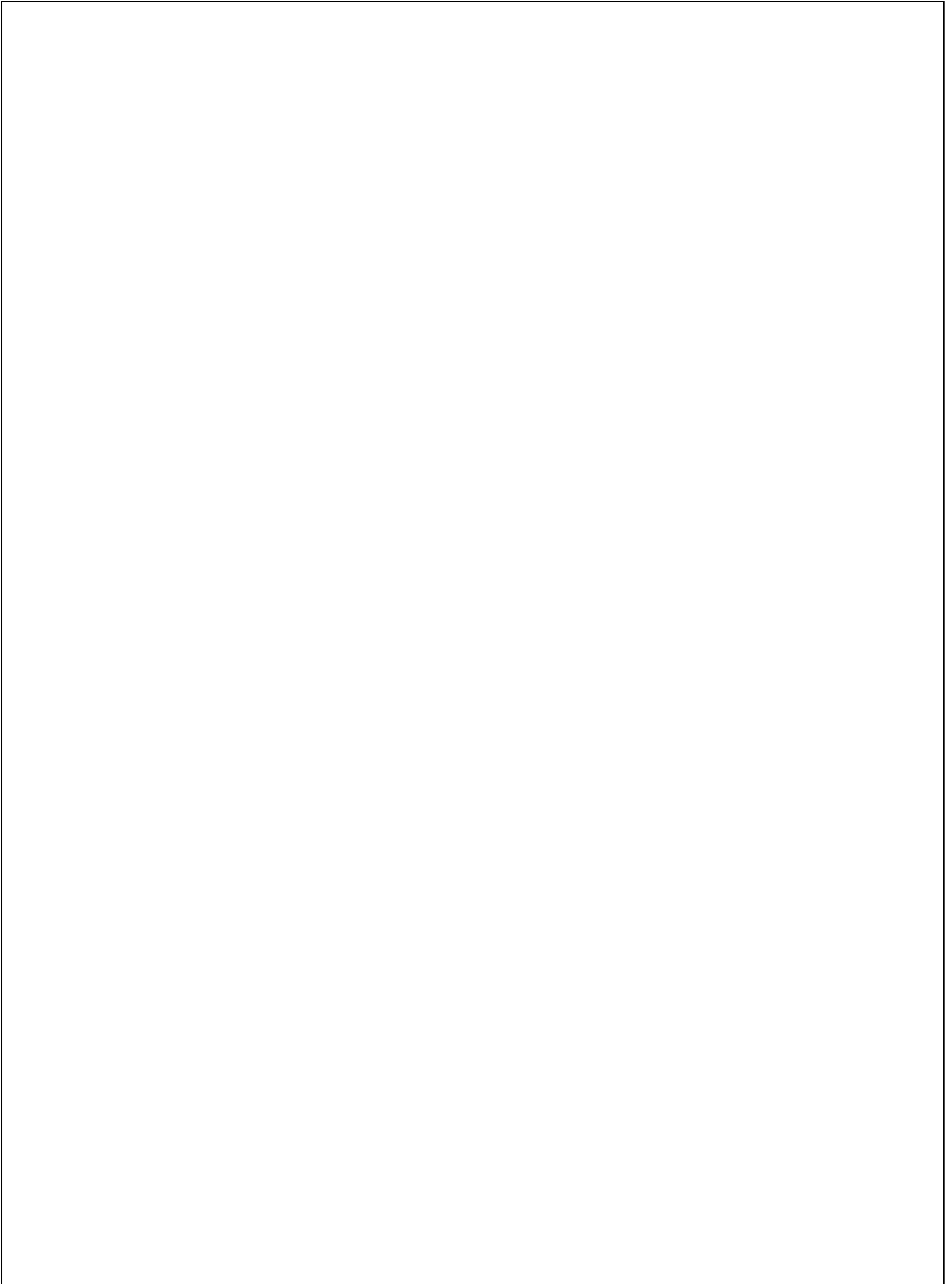

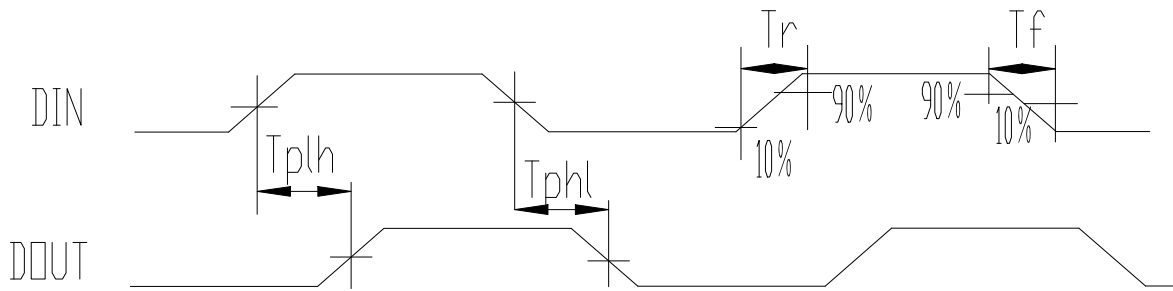

%% H\Y XUhU hfUbga] gg] cb h] aY

&) & F; 6=7					
H	7cXY	A] b	Hnd] W	AU	l b] h
HC<	\$	&()	&-)	'()	bg
HC@	\$)())-)	*()	bg
H%<	%)())-)	*()	bg
H%@	%	&()	&-)	'()	bg
Hfgh	FYgYh	, \$!!	!!	i g

%%" HYadcfU` kUj YZcfa Z][i fY

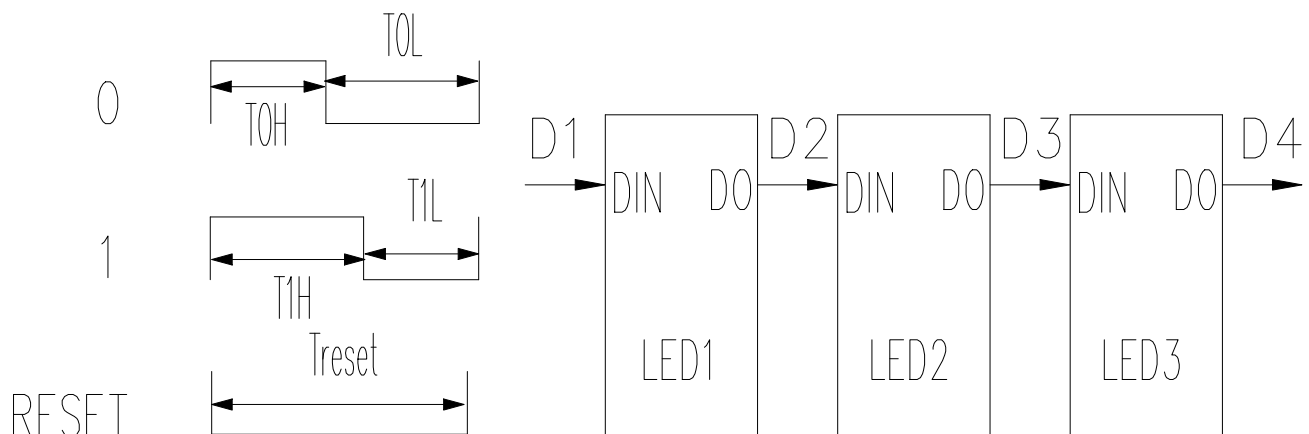

% " AcXY cZ XUhU hfUbga] gg] cb

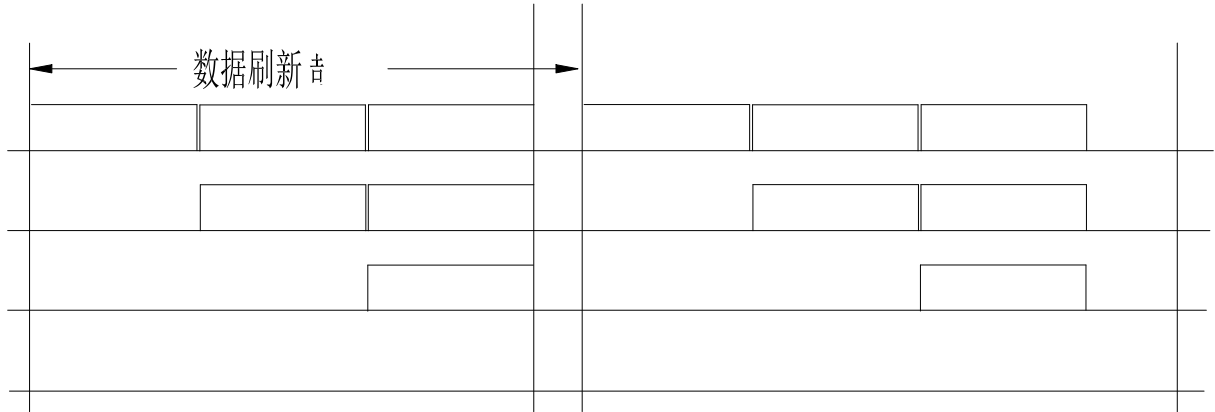

LIG

LIGHT ELECTRONICS CO., LTD.

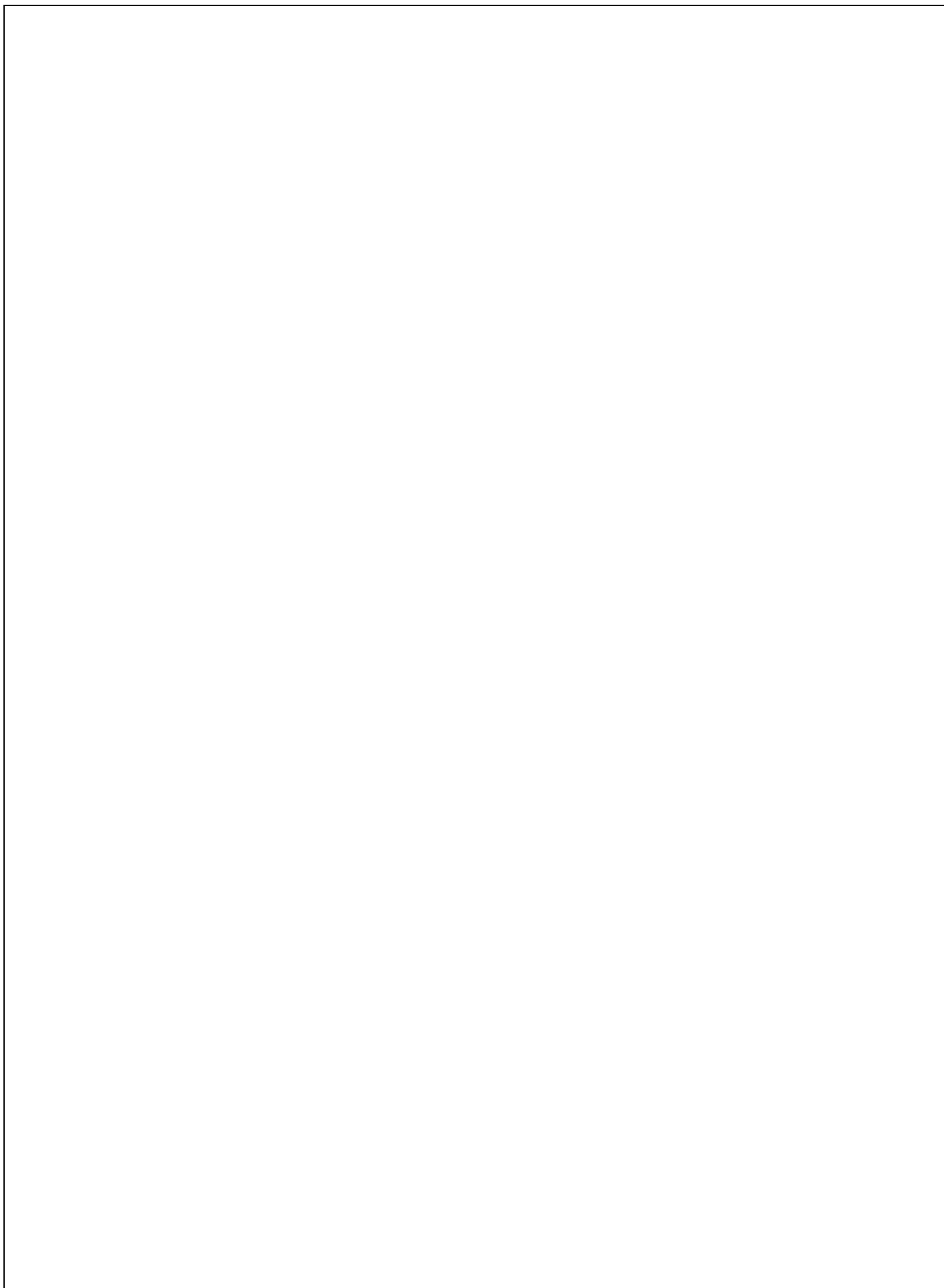

%" DUW_U[] b[GdYV\ Z] W\h] cbg

: YXX] b[8] fYVh] cb

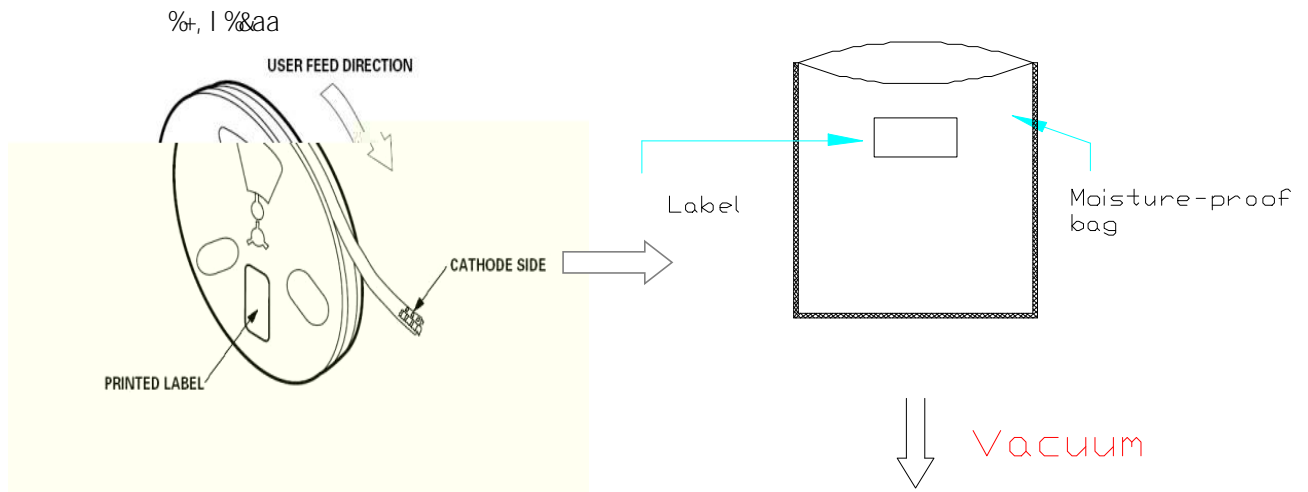
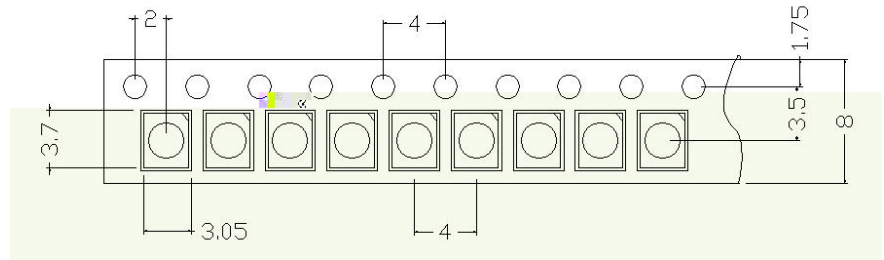

LIGHT	
Light Electronics CO., LTD.	
MODEL NAME: _____	 LOT NO. : CN
QUANTITY: _____	
BIN _____	
PACKING DATE: _____	
CUSTOMER P/N: _____	

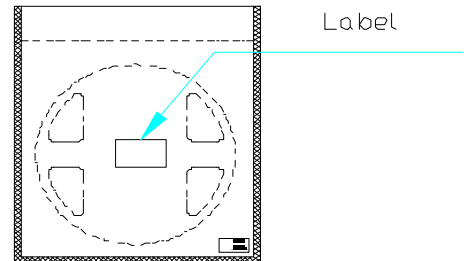
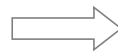

BchY. jc`iaY]g &\$\$\$dVg/

&\$\$\$dVg

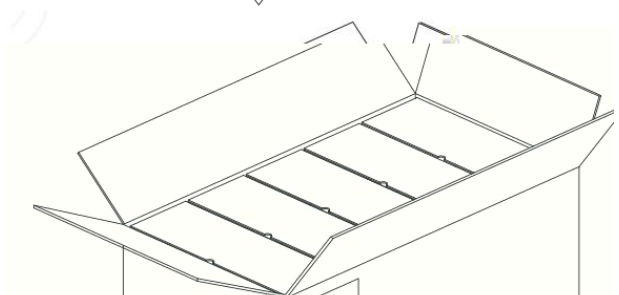



% " FY`]U]`]hm

H9GH =H9AG 5B8 F9GI @HG

	HYgh =hYa	FYZ" GhUbXUfX	HYgh 7cbX] h] cbg	BchY	7cbWi g] cb
%	FYZ` ck Gc` XYf] b[>9G8&&! 6%\$*	Hg` X1&(\$ ž%\$gYW	' h] aYg	\$#&&
&	HYadYfUhi fY 7mWY	>9G8&&! 5%\$(! &\$ ' \$a] b %&\$ ' \$a] b	&\$ \$ WmWY	\$#&&
,	HYfaU` G\cW_	>9G8&&! 5%\$*	! (\$ %&a] b %&) %&a] b	&\$ \$ WmWY	\$#&&
(<] [\ HYadYfUhi fY GhcfU[Y	>9G8&&! 5%\$'	H,1%\$\$	%\$\$\$ \fg	\$#&&
)	@ck HYadYfUhi fY GhcfU[Y	>9G8&&! 5%%	H,1! (\$	%\$\$\$ \fg	\$#&&
*	DckYf hYadYfUhi fY 7mW] b[>9G8&&! 5%\$)	Cb) a] b! (\$ 2%&a] b 0%&a] b CZZ) a] b%\$\$ 2%&a] b	&\$ \$ WmWY	\$#&&
+	@]ZY HYgh	>9G8&&! 5%\$,	H,1&) = 1%&a5	%\$\$\$ \fg	\$#&&
,	<] [\ <i a] X] hm <YUh @]ZY HYgh	>9G8&&! 5%\$%	*\$ F<1- \$i = 1%&a5	%\$\$\$ \fg	\$#&&

% " FYZ` ck dfcZ]` Y

GAB FYZ` ck Gc` XYf] b[=bghfi W] cbg

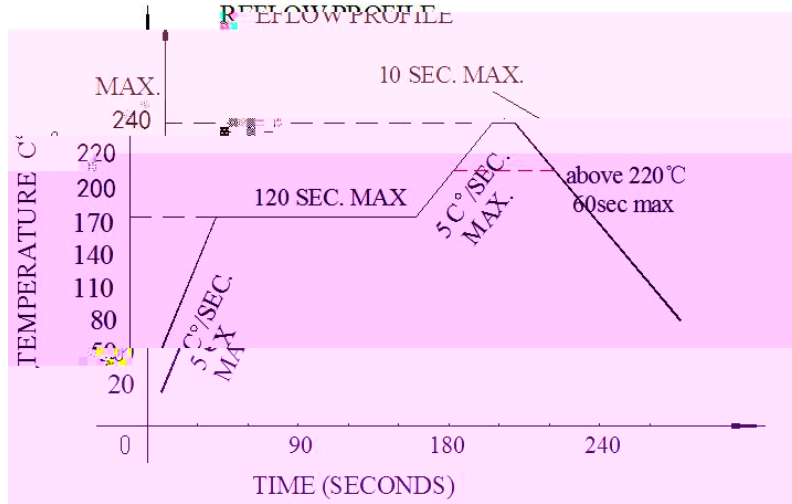

U" FYZ` ck gc` XYf] b[g\ci` X bch VY XcbY acfY h\Ub hkc h] aYg

&

V" K\Yb gc` XYf] b[žXc bch di h ghfYgg cb h\Y @98g Xi f] b[\YUh] b[

@98

Gc` XYf] b[] fcb

U" K\Yb \UbX gc` XYf] b[ž _YYd h\Y hYadYfUhi fY cZ h\Y] fcb i bXYf ' \$\$ ž UbX Uh h\Uh

hYadYfUhi fY _YYd h\Y h] aY i bXYf ' gYW

' \$\$

V" H\Y \UbX gc` XYf] b[g\ci` X VY XcbY cb` m U h] aY

FYkcf_

U" 7i ghcaYf ai gh Z] b] g\ fYkcf_ k] h\] b) gYWi bXYf & (\$

& (\$)

V" H\Y \YUX cZ] fcb WUb bch hci WX h\Y @98g

@98

W Hk] b! \YUX hmdY] g dfYZYffYX"

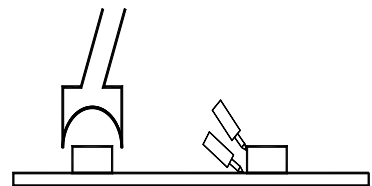



&\$" 75I H=CBG

BchY Zcf i gY

=b cfXYf hc Ybgi fY h\Uh =7 `Uad VYUXg UfY i gYX]b GAH dUhW\ fYZ` ck kY` X]b[UbX]b h\Y i gY cZ h\Y dfcWgg m]Y` X UbX ghUV]`]hmcZ h\Y dfcXi Vhž h\Y Zc` `ck]b[dfcW\Xi fYg UfY gdYW\Z]YX UZhYf aUbm hYghg.

=7 GAH

U GUad` Y Yj U i Uh]cb. 6YW\i gY h\]g dfcXi Vh]g U Vi]` h!]b =7 dfcXi Vhž h\Y cj YfU` `dfcWgg]g X]ZZYfYbh Zfca V\bj Ybh]cbU` F; 6 dfcXi Vhž gc h\Y WghcaYf g]XY bYYXg hc W\ffm ci h U` ! fci bX j Yf]Z]W\h]cb Xi f]b[h\Y GUad` Y Yj U i Uh]cb hc Ybgi fY h\Y aUhW\]b[dYfZcfaUbW\ cZ h\Y dfcXi Vh

=7 F; 6

V =bV\ta]b[aUhYf]U`]bgdYW\]cb. Ybgi fY h\Y j UW\i a dUW\]b[]g]bhUW\ UbX h\YfY]g bc j UW\i a `YU_U[Y" =Z h\YfY]g j UW\i a `YU_U[Yž d` YUgY V\bz]fa k\Yh\Yf h\Y fYZ` ck kY` X]b[]g UWbcfaU " =Z]h]g UWbcfaU ž d` YUgY fYhi fb hc h\Y ZUW\hcfm Zcf \][\! hYadYfUhi fY XY\i a]X]Z]W\h]cb"

W I gY. D` YUgY V\bz]fa h\YY\,fzi bYZ\ D



X AU] bhYbUbW. aUhYf] U` g\ci ` X VY Wcad` YhYX k] h\] b (\ci fg UbX XcaYgh] WXYaUbX UZhYf
 fYZ` ck gc` XYf] b[hYgh UbX fYdU] f h\Y ` Uad VYUXž gi Wk Ug acfY h\Ub (\ci fg bYYX hc fYdU] f
 h\Y ` Uad d` UhY hYadYfUhi fY UVcj Y *) XY\i a] X] Z] WUh] cb %& \ci fg hc fYdU] f kcf_ž UbX
 fYdU] f h\Y ` Uad VYUX U` gc ai gh Wffmcb h\Y ` ck hYadYfUhi fY UVcj Y *) XY\i a] X] Z] WUh] cb
 %& \ci fgž i gY dfc\] V] hYX] b h\Y dfcWgg cZ aU] bhYbUbW k] h\ hYadYfUhi fY cj Yf &(\$
 \YUh] b[aUW] bY fYdU] fž dfc\] V] h h\Y k\c` Y d` UhY d` UWYX] b h\Y \YUh] b[ghU[Y fYdU] fž
 Zc` ` ck h\Y df] bW] d` Y cZ VUX k\] Wk fYhi fb k\] Wk aYUgi f] b["

((*) %& *) %& &(\$

Y KUfa dfcadh. h\Y k\c` Y dfcWgg gdYW] U` Wcbg] XYfUh] cbg Zcf `] [\h VYUX VYZcfY i gY
 j UW] i a dUW] b[ž XY\i a] X] Z] WUh] cbž GAH d` UW] aYbh h] aY UbX kcf_g\cd cZ hYadYfUhi fY UbX
 \i a] X] hmWcbhfc` ž dfcXi Wk aU] bhYbUbW ` Uad d` UhY] Z VUFY Uh fcca hYadYfUhi fY Ybj] fcbaybh
 Zcf U` cb[h] aY bYYX hc XY\i a] X] Z] WUh] cbž `] [\h VcUFX UbX `] [\h VYUX `] [\h VYUXg Ug @98
 Y` YW] fcb] WdfcXi Wkž bYYX hc dUm UhhYbh] cb hc ac] ghi fY] b gdf] b[UbX gi aaYfž Ui hi ab UbX
 k] bhYf Ubh] ! ghUh] Wž dfcXi Wk ei U] hm] g YbhYf df] gYfig `] ZYž hc h\Y ei U] hmghf] j Yg Zcf h\Y
 gi fj] j U ž hc h\Y ei U] hmghf] j Yg Zcf h\Y XYj Y` cdaYbh] g ci f Wcbg] ghYbh U] a" 5` gc] b cfXYf
 hc Ybgi fY h\Y ei U] hmcZ h\Y W] Ybhž d` YUgY ghf] Wk` m fYZYf hc h\Y UVcj Y fYWcaYbXUh] cbg

@98

LIGHT

LIGHT ELECTRONICS CO., LTD.

