

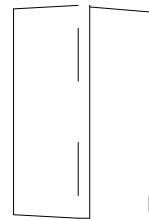

## Features

- Pb free product—RoHS compliant
- Low power consumption, High efficiency
- Reliable and rugged
- Long life – solid state reliability
- Viewing angle: 120°

## Package Dimension

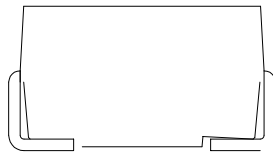

Part NO.	Lens Color	Source Color
SL-T3528IRURPC010-L180	Water Clear	Infrared/Red/Purple

### Notes:

1. All dimensions are in millimeters.
2. Tolerance is  $\pm 0.10$ mm unless otherwise noted.
3. Specifications are subject to change without notice.

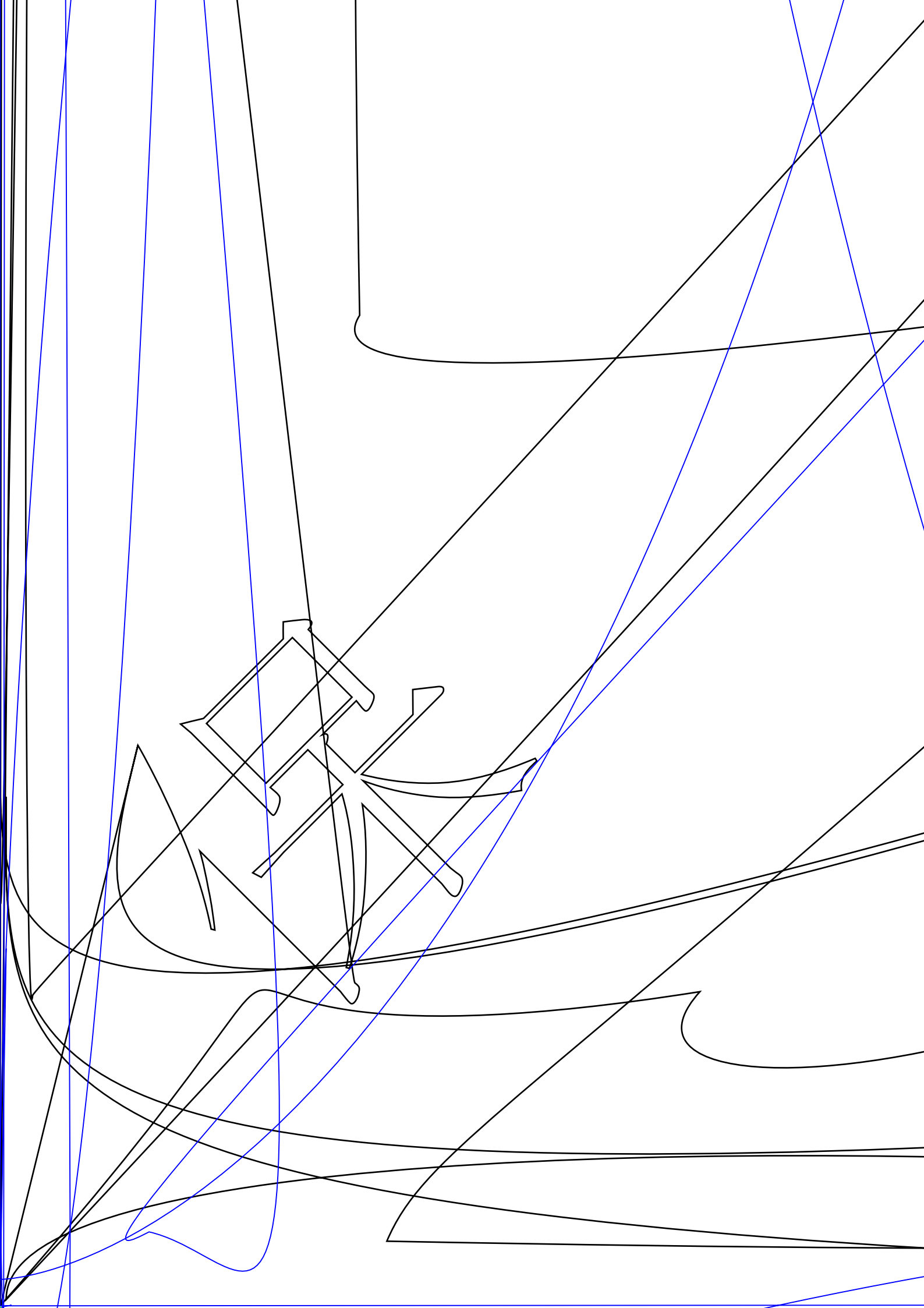

## Electrical Optical Characteristics at Ta=25°C

Parameter	Symbol	Color	Min.	Typ.	Max.	Unit	Test Condition
Radiant Intensity	I <sub>e</sub>	Infrared	1.0	2.0	---	mW/sr	I <sub>F</sub> =10mA
Luminous Intensity	I <sub>v</sub>	Red	200	330	---	mcd	I <sub>F</sub> =10mA
		Purple	10	22	---	mcd	I <sub>F</sub> =10mA
	1/2	---	---	120	---	Deg.	(Note 2)
Peak Emission Wavelength		Infrared	---	850	---	nm	I <sub>F</sub> =10mA
		Red	---	635	---	nm	I <sub>F</sub> =10mA

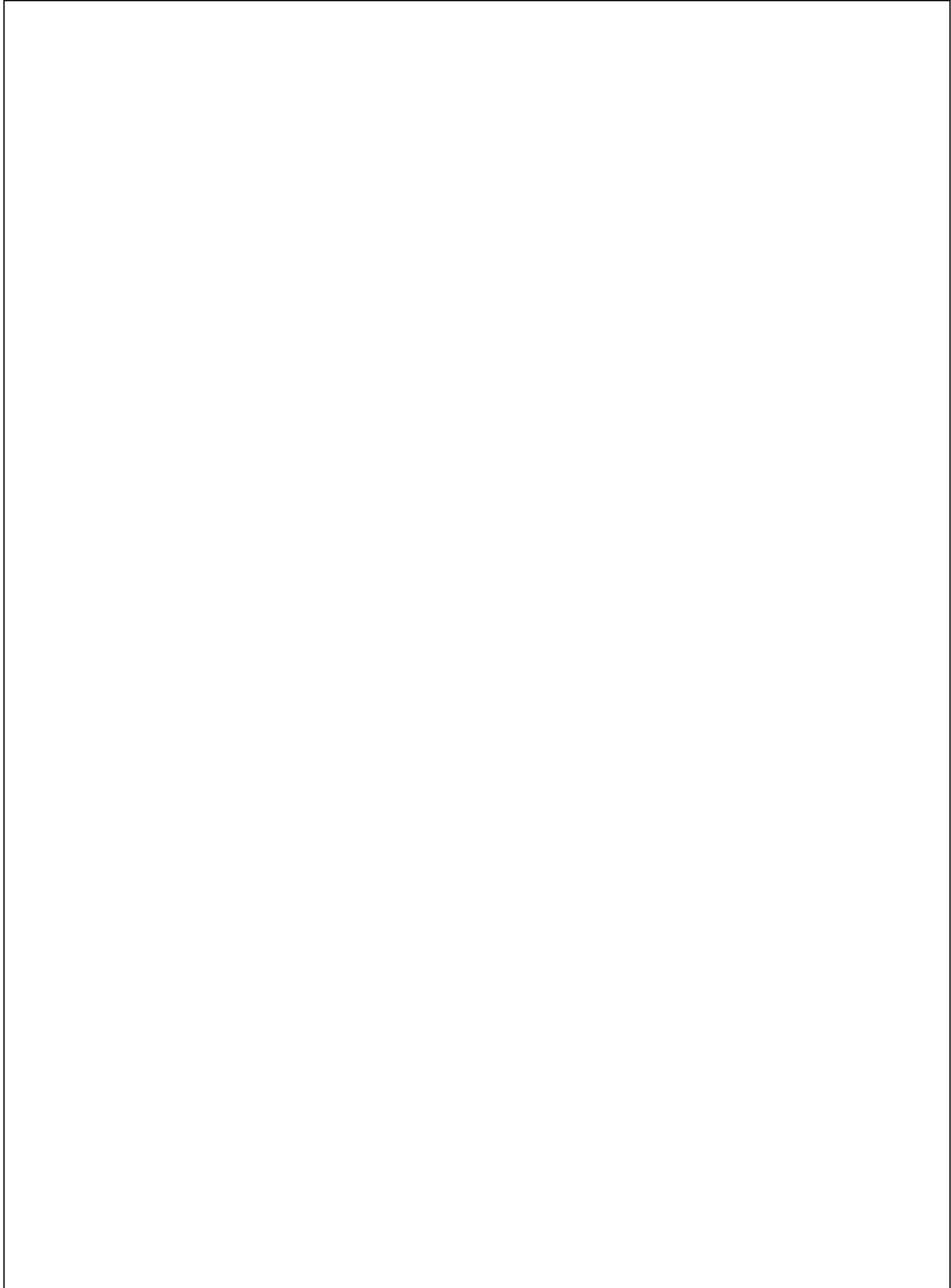

## Typical Electrical / Optical Characteristics Curves for Red (25°C Ambient Temperature Unless Otherwise Noted)

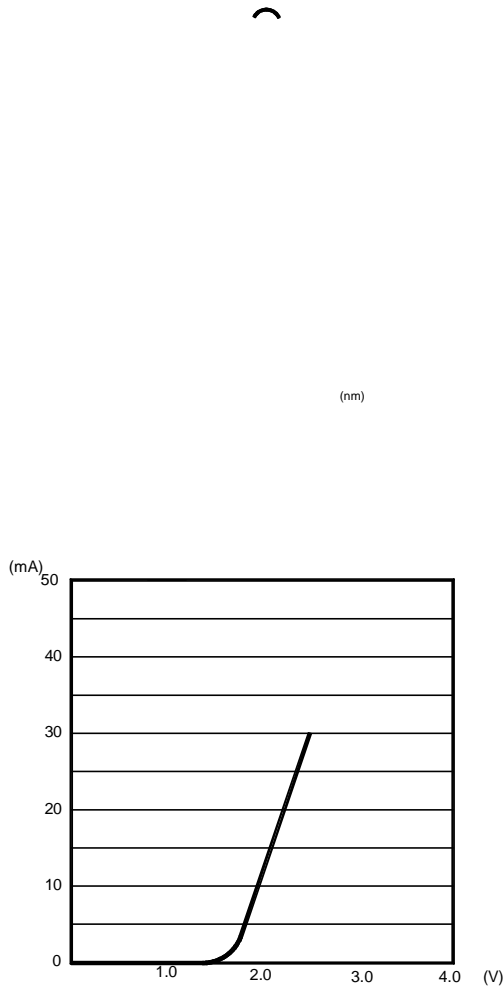

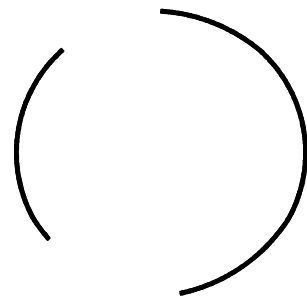
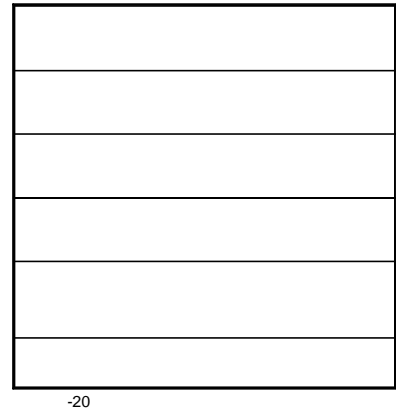

(nm)







## Label Explanation

LIGHT Universal Label

<b>LIGHT</b>		
Light Electronics CO., LTD.		
MODEL NAME: _____	 LOT NO. : _____	
QUANTITY: _____		
BIN: _____		
PACKING DATE: _____		
REMARKS: _____		

Customer Defined Label

<b>LIGHT</b>		
Light Electronics CO., LTD.		
MODEL NAME: _____	 LOT NO. : _____	
QUANTITY: _____		
BIN: _____		
PACKING DATE: _____		
CUSTOMER P/N: _____		

## Reel Dimensions

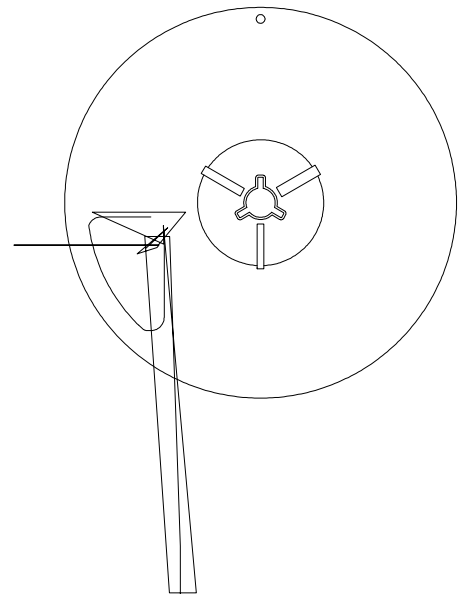
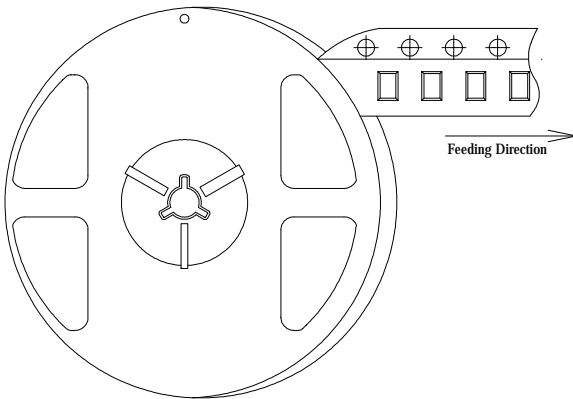

**Note:** Tolerance unless mentioned is  $\pm 0.2\text{mm}$ ; Unit = mm

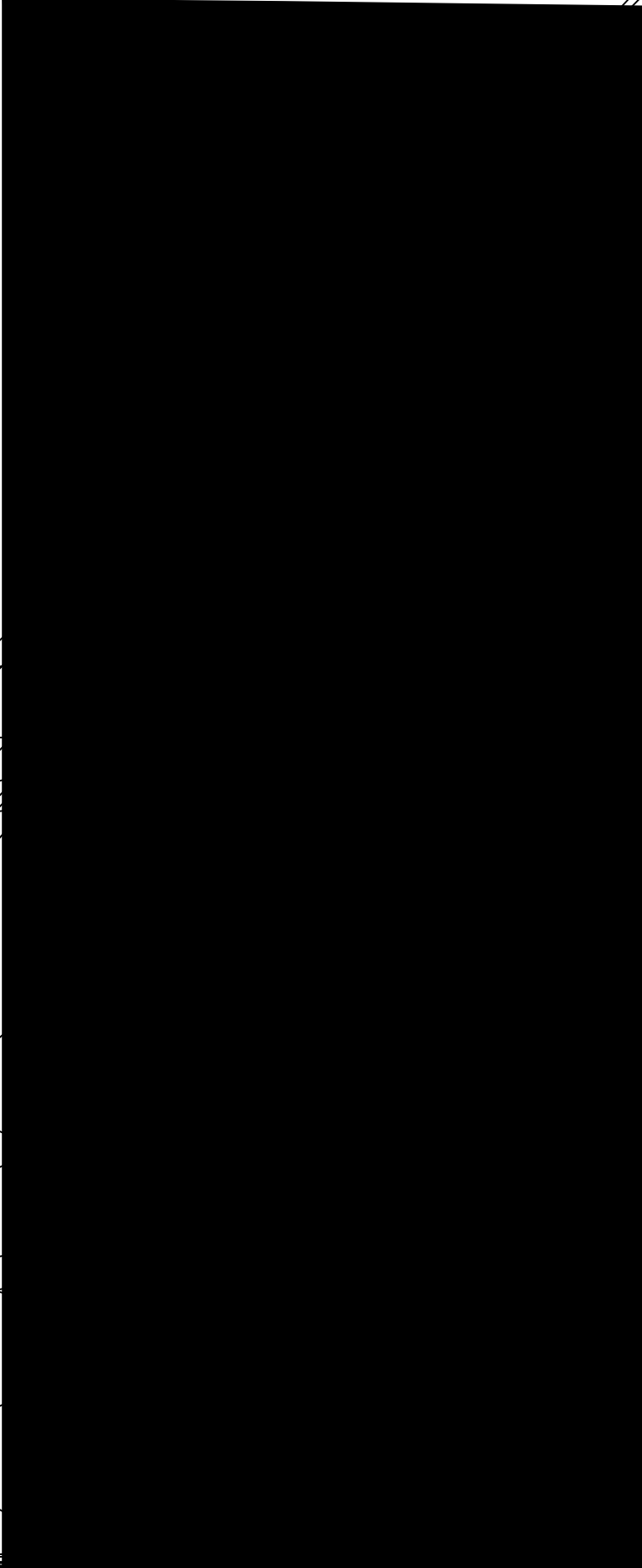
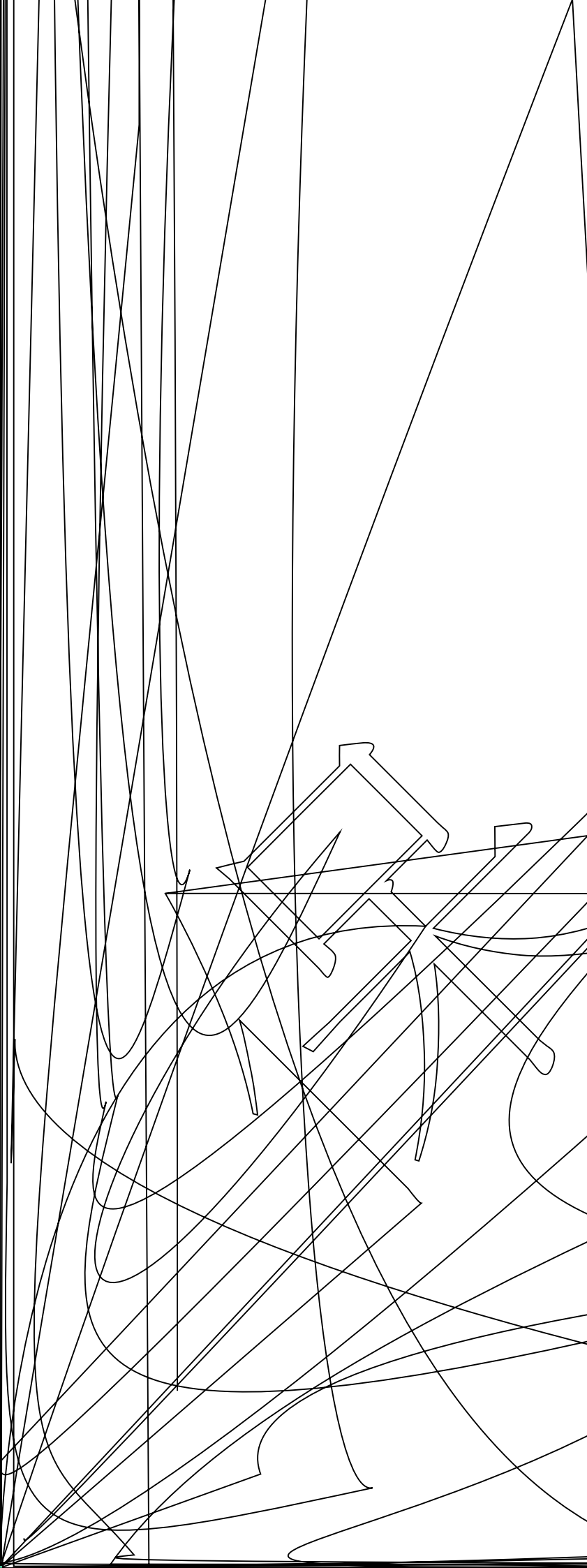

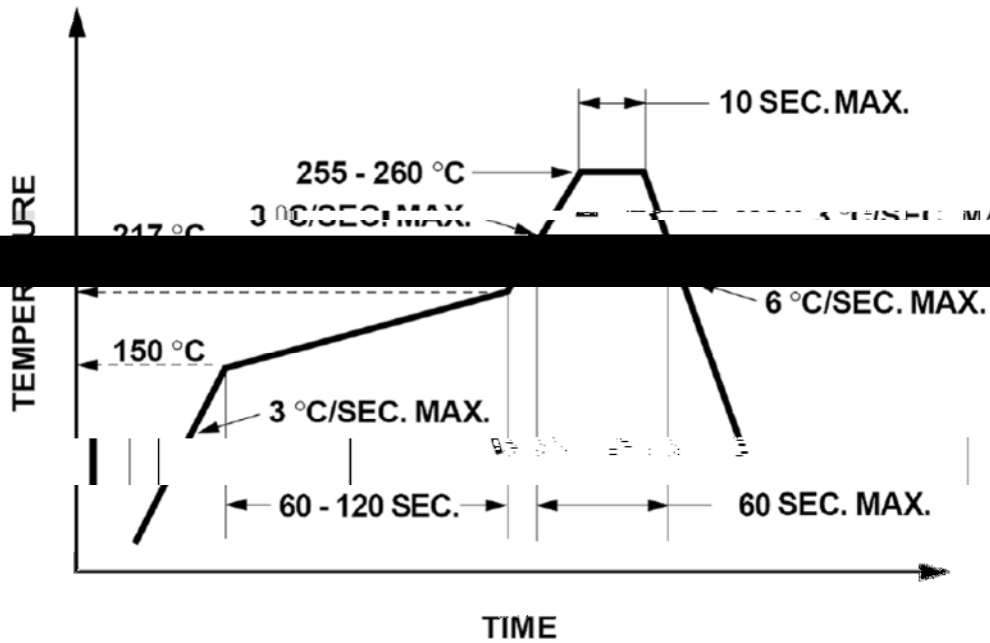

1. Reflow soldering should not be done more than two times.
2. When soldering, do not put stress on the LEDs during heating.

**Soldering iron**

1. When hand soldering, the temperature of the iron must less than 300°C for 3 seconds.
2. The hand solder should be done only once.

**Repairing**

Repair should not be done after the LEDs have been soldered. When repairing is unavoidable, a double-head soldering iron should be used (as below figure). It should be confirmed beforehand whether the characteristics of LEDs will or will not be damaged by repairing.

