

SL-T3528IR-850-1.4-R

DATA SHEET

SPEC. NO. : SZ20030501
DATE : 2020/03/05
REV. : A/1

Approved By:

Checked By:

Prepared By:

Features

- Pb free product—RoHS compliant
- Low power consumption, High efficiency
- Reliable and rugged
- Long life – solid state reliability
- Radiant angle: 120°

Package Dimension

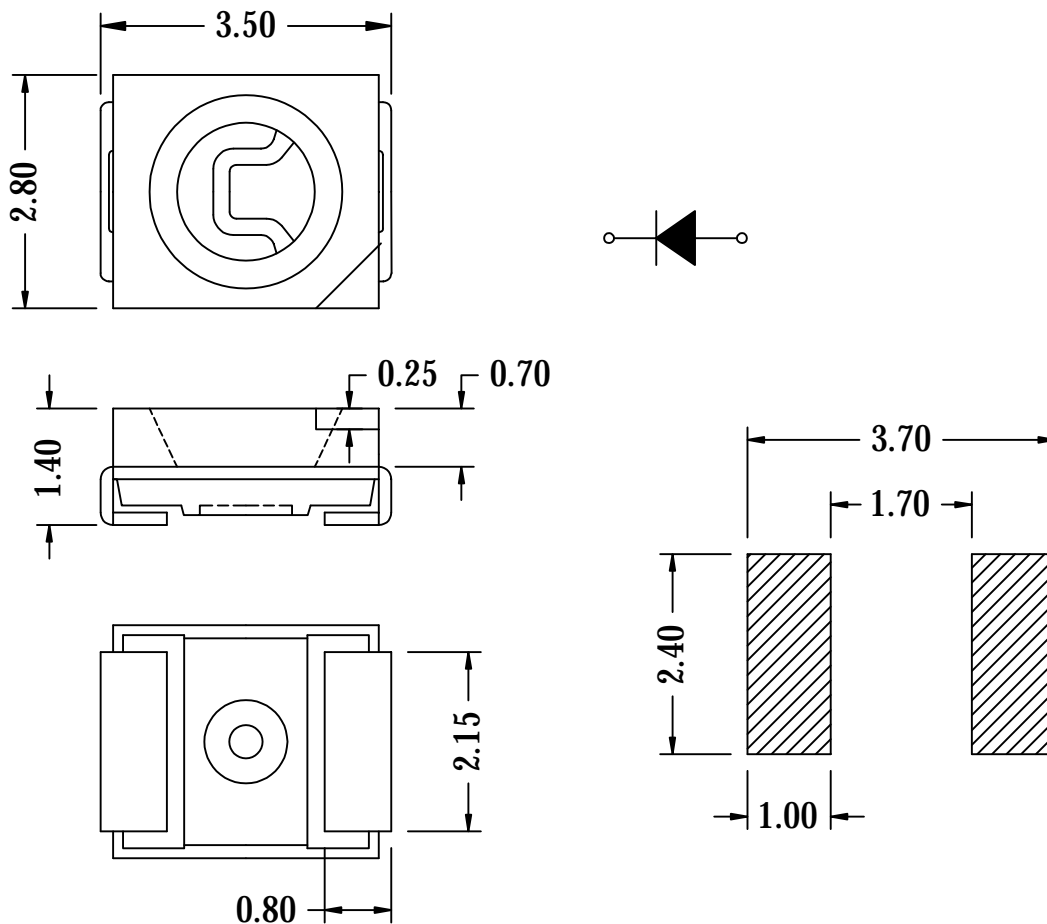

Part NO.	Chip Material	Lens Color
SL-T3528IR-850-1.4-R	AlGaAs/Si	Water Clear

Notes:

1. All dimensions are in millimeters.
2. Tolerance is ± 0.10 mm unless otherwise noted
3. Specifications are subject to change without notice.



PartNo .SL

Typical Electrical / Optical Characteristics Curves (25 Ambient Temperature Unless Otherwise Noted)

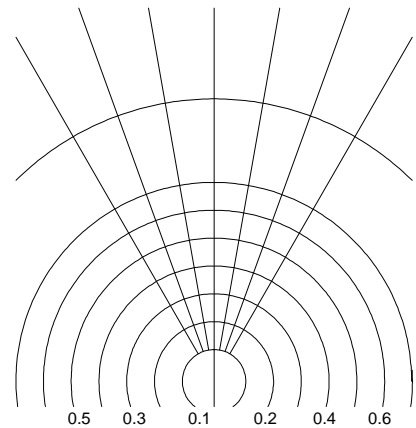
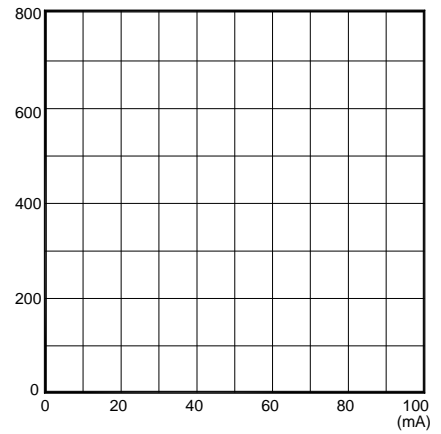
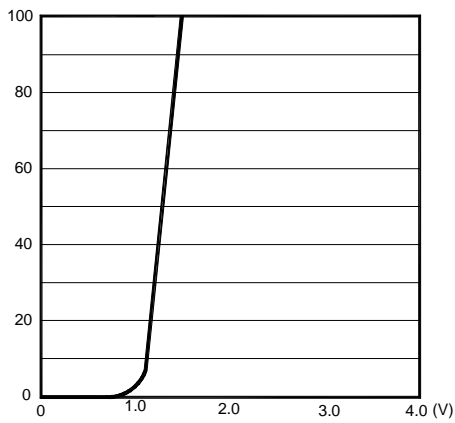
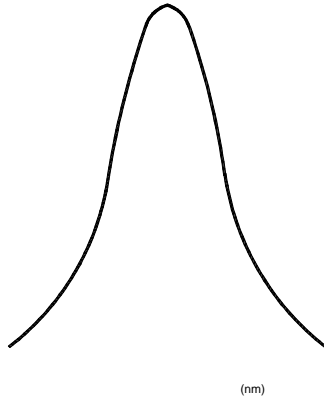

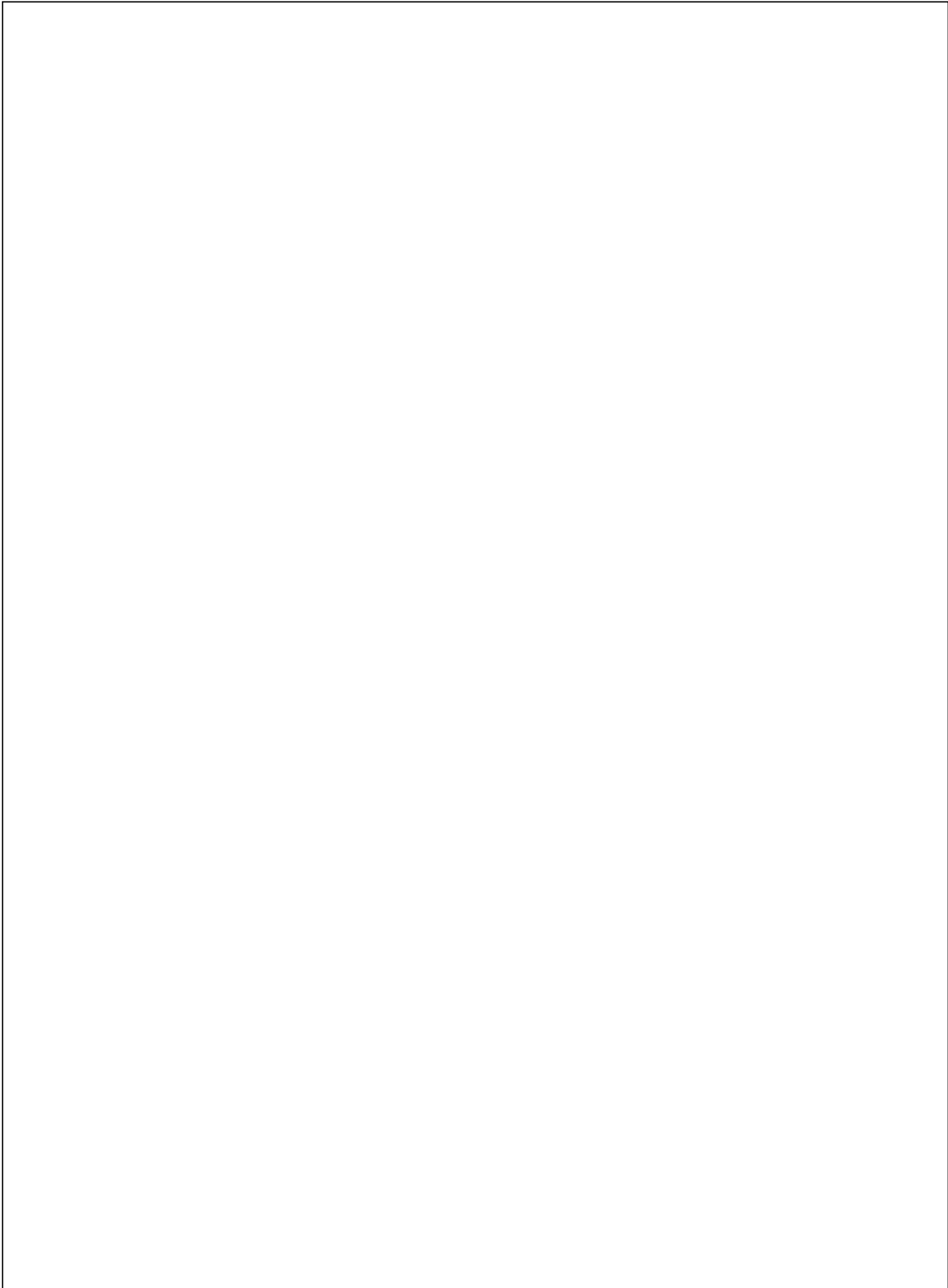

Part No.	SL-T3528IR-850-1.4-R	Page	6 of 9
-----------------	-----------------------------	-------------	---------------

Light Electronics CO., LTD.

Label Explanation

LIGHT	
Light Electronics CO., LTD.	
MODEL NAME: _____	 LOT NO. : _____
BIN QUANTITY: _____	
BIN _____	
PACKING DATE: _____	
REMARKS: _____	

