

**LIGHT ELECTRONICS CO., LTD.**

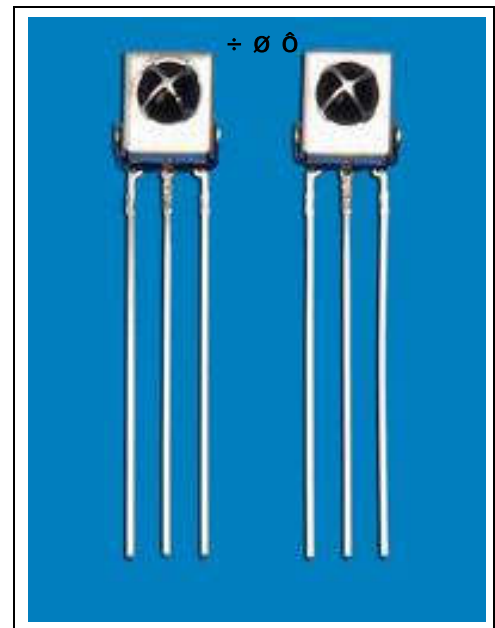

<b>Part No.</b>	<b>LG-IRM2A438KSF3</b>		
-----------------	------------------------	--	--

1 IRM2A438 SF3 PIN  
IC  
REACH ROHS



2 2.7-5.5V

3 TTL CMOS

3 : ( NP3 NPã, ä ä æ ç è  
é ê ë ì í î é ê í ç ì  
ñ ò

ã ó ô :

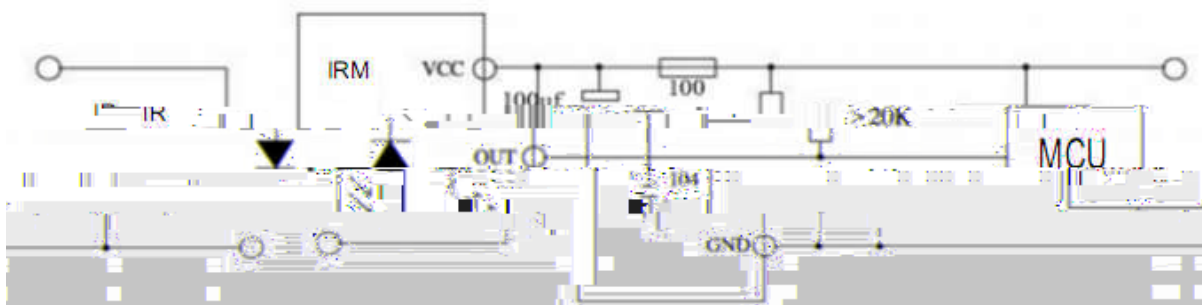

5 ó ô ô

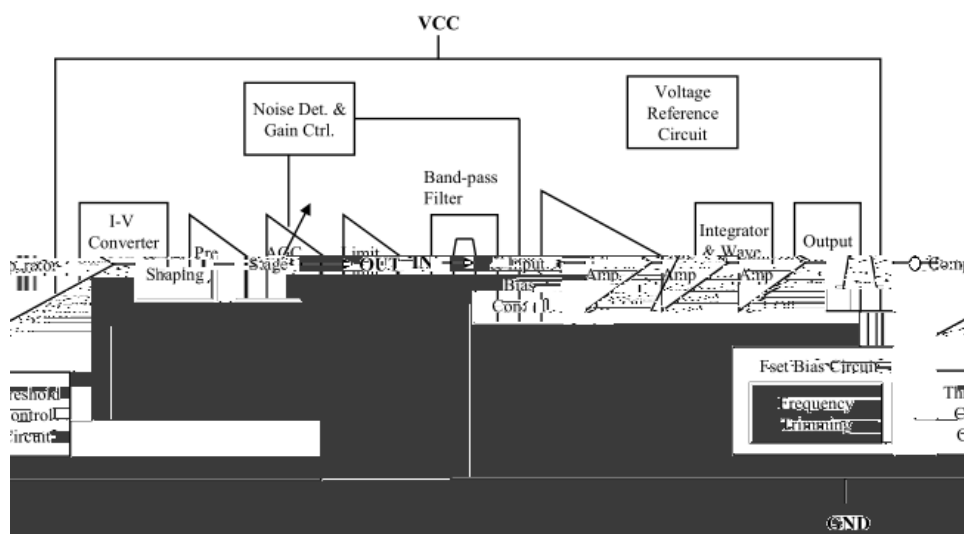

**LIGHT ELECTRONICS CO., LTD.**

L

**LIGHT ELECTRONICS CO., LTD.**

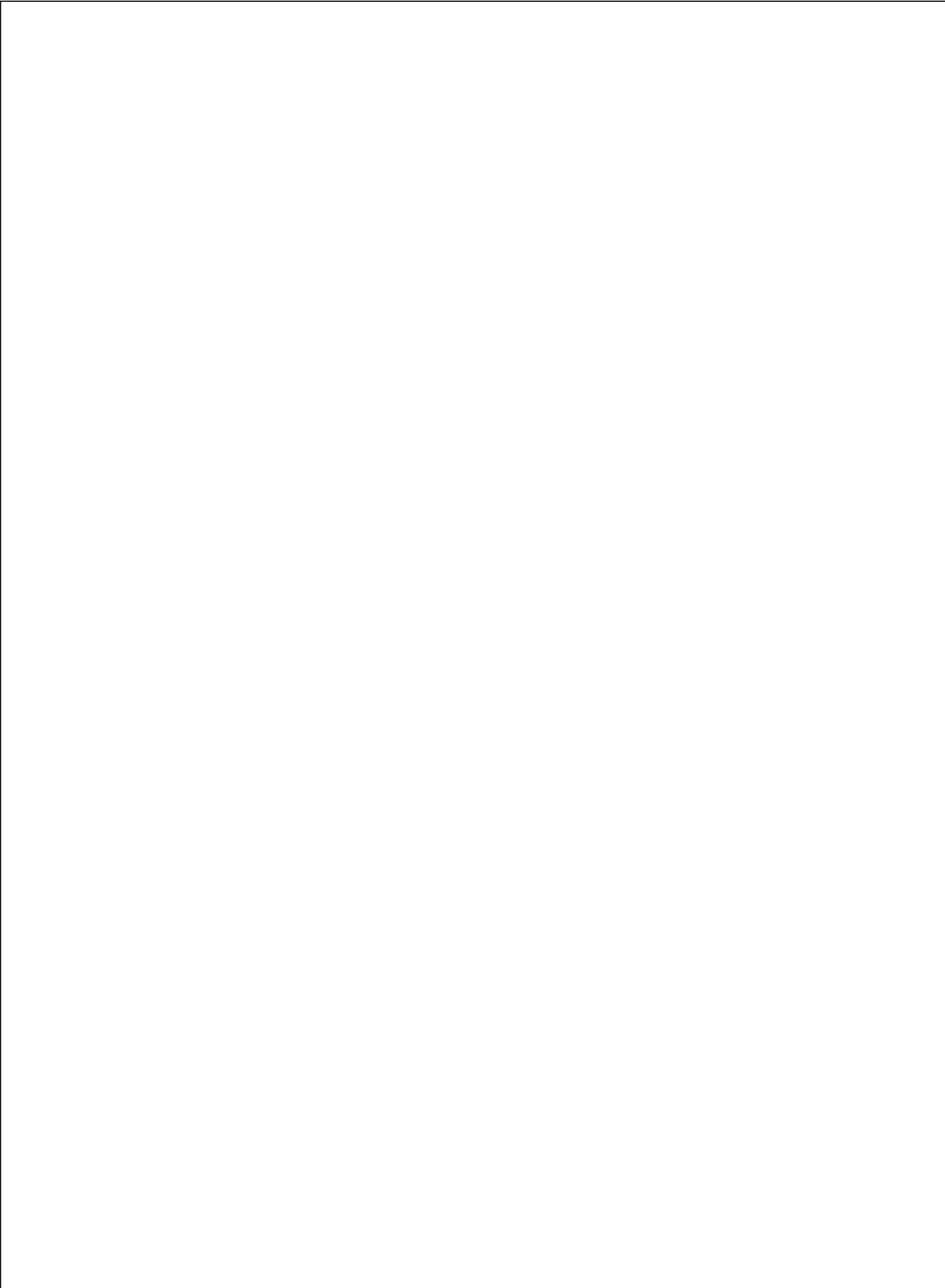

1ã

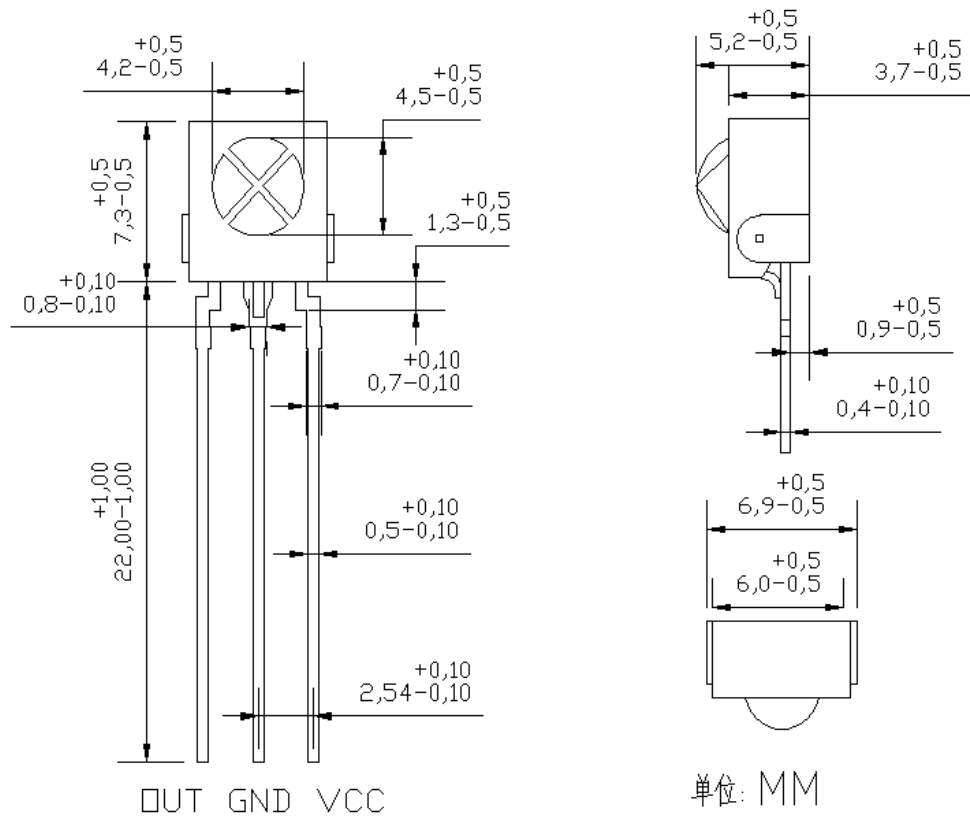

15

1è.

3 : 26pü 5 , ,  
2  
3

16.

1è.      è      ô ï

150mm× 190mm

ú      5pPCS

2è.

ô

ú      5pPCS

1p

ã

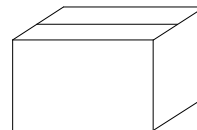
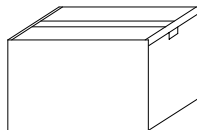
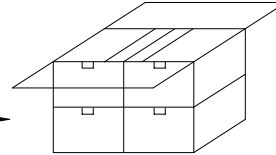
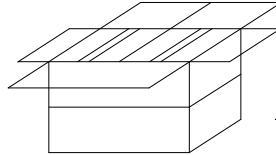
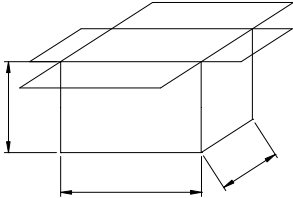
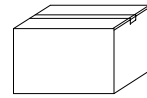
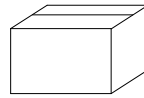
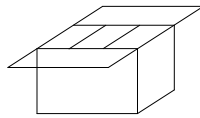
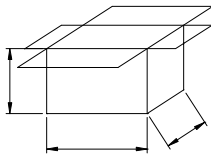
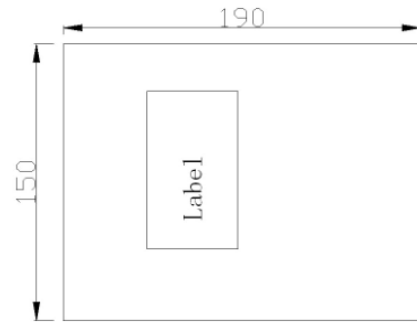

( pcs / )	( / )	( / )
<b>500</b>	<b>10</b>	<b>4</b>