

LG-05IR3C94C-544A-T1

DATA SHEET

SPEC. NO. : SZ21032903
DATE : 2021/03/29
REV. : A/0

Approved By:

Checked By:

Prepared By:

Features

- ◆ Pb free product RoHS compliant
- ◆ Low power consumption, High efficiency
- ◆ General purpose leads
- ◆ Reliable and rugged
- ◆ Long life solid state reliability
- ◆ Radiant angle: 20 °

Package Dimension

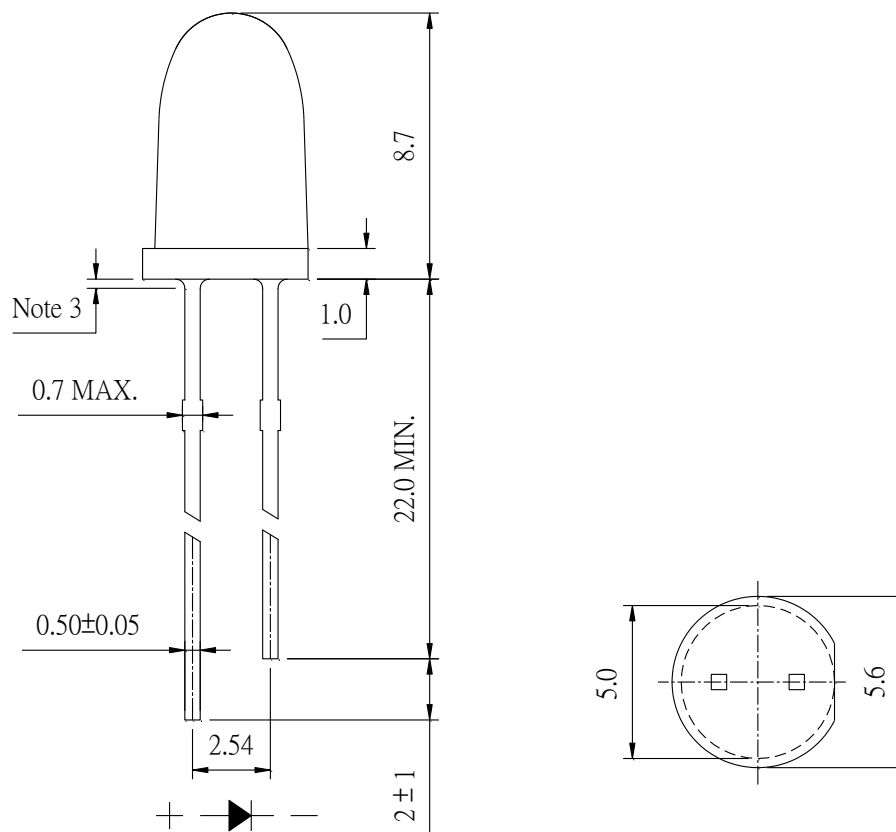

Part NO.	Chip Material	Lens Color
LG-05IR3C94C-544A-T1	AlGaAs	Water Clear

Notes:

1. All dimensions are in millimeters.
2. Tolerance is 0.20mm unless otherwise noted.
3. Protruded resin under flange is 1.0mm max.
4. Lead spacing is measured where the leads emerge from the package.
5. Specifications are subject to change without notice.

LIGHT

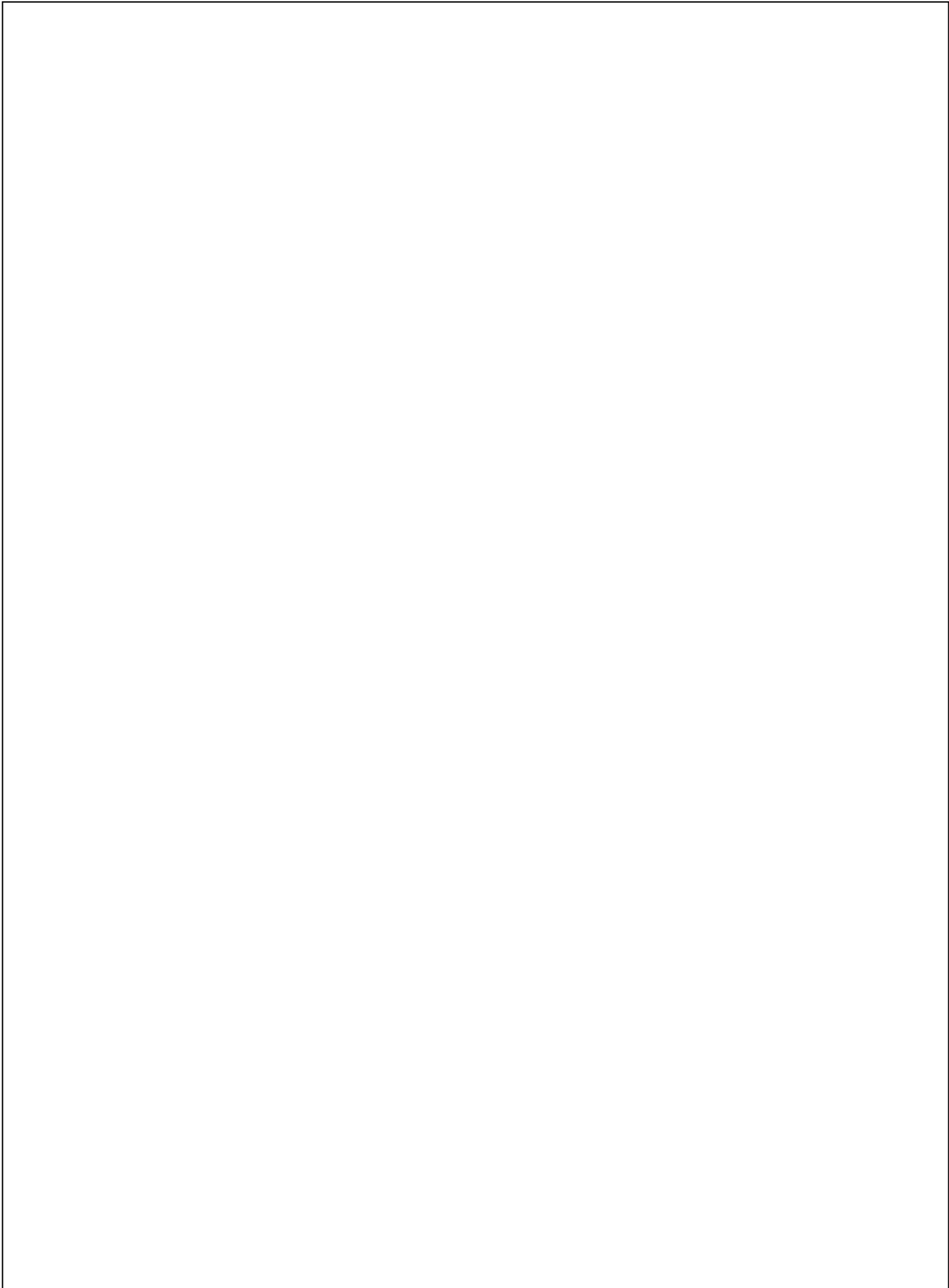

Electrical Optical Characteristics at Ta=25

Parameter	Symbol	Min.	Typ.	Max.	Unit	Test Condition
Radiant Intensity	I _e	31	45	64	mW/sr	I _F =20mA (Note 1,3)
Viewing Angle	1/2	---	20	---	deg.	(Note 2)
Peak Wavelength		---	940	---	nm	I _F =20mA
Spectral Line Half- Width	Δ	---	50	---	nm	I _F =20mA
Forward Voltage	V _F	---	1.2	1.5	V	I _F =20mA
Reverse Current	I _R	---	---	100	μA	V _R =5V

Note:

- Point sources of the amount of radiation per unit time in a given direction within the unit solid Angle radiated energy.
- axis angle at which the Radiant Intensity is half the axial Radiant Intensity.
- The I_e guarantee should be added 15% tolerance.

Recommended Wave Soldering Profile

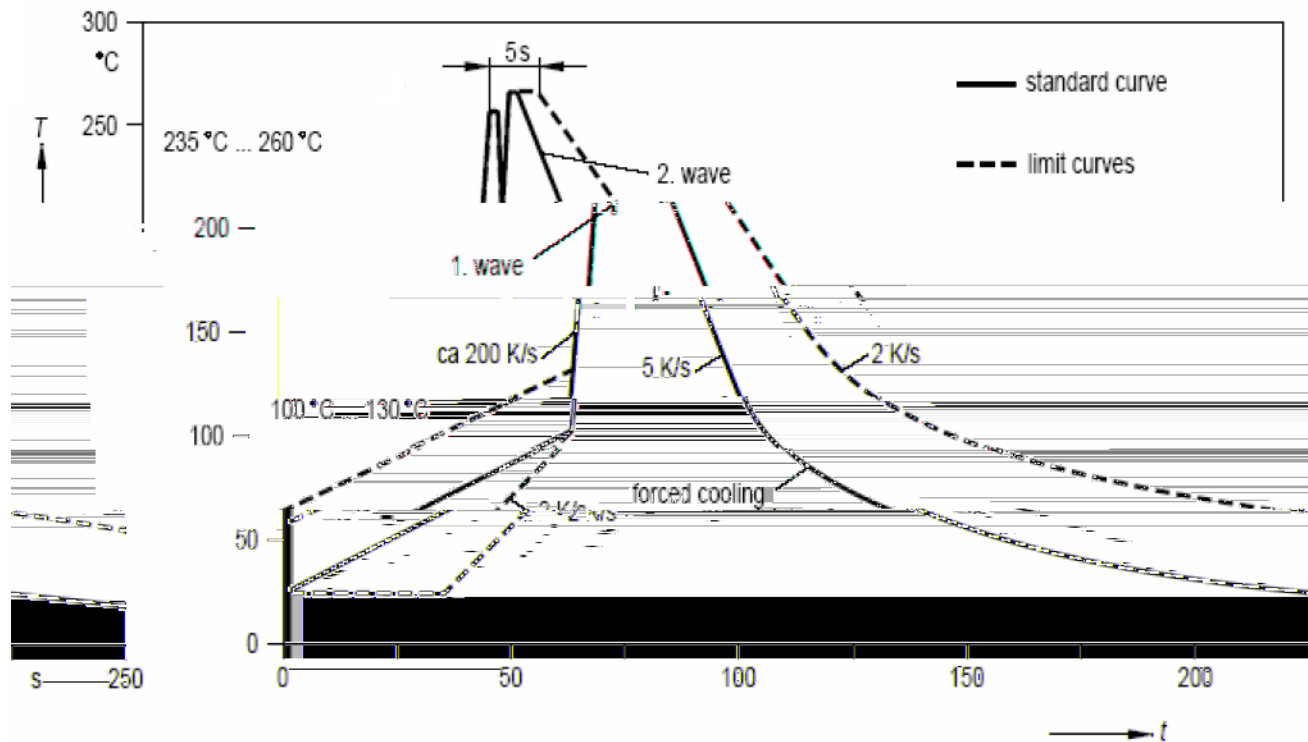

Typical Electrical / Optical Characteristics Curves
(25 Ambient Temperature Unless Otherwise Noted)

Infrared Emitting Diode Specification

●Commodity: Infrared emitting diode

●Radiant Intensity Bin Limits (At 20mA)

BIN CODE	Min.(mW/sr)	Max. (mW/sr)
1	31	37
2	37	44
3	44	53
4	53	64

NOTE: The Ie guarantee should be added 15% tolerance.

PACKAGE

LED MOUNTING METHOD

1. The lead pitch of the LED must match the pitch of the mounting holes on the PCB during component placement. Lead-forming may be required to insure the lead pitch matches the hole pitch. Refer to the figure below for proper lead forming procedures.(Fig.1)

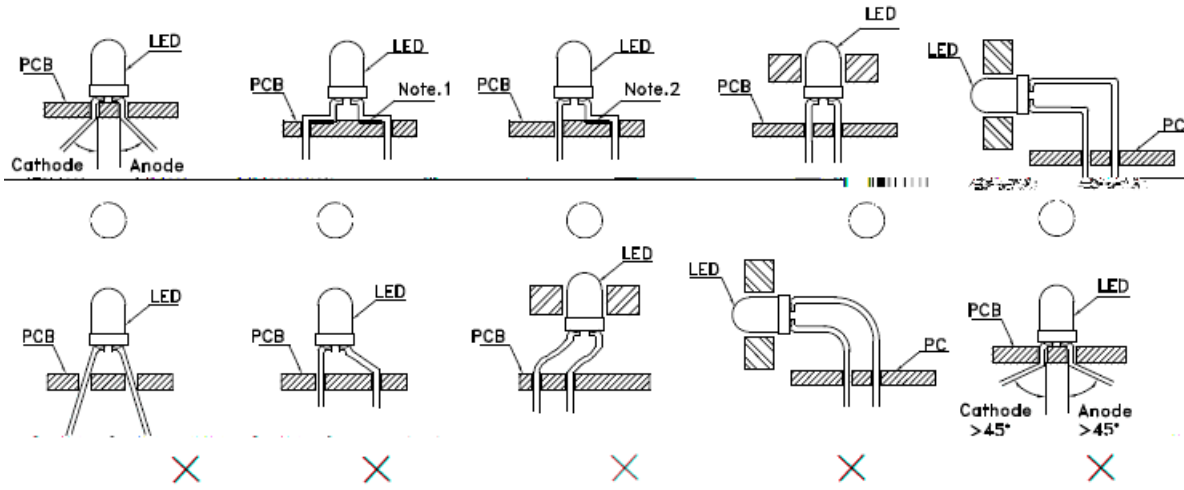

-2: Do not route PCB

Trace in the contact area between the lead frame and the PCB to prevent short-circuit.

2. When soldering wire to the LED, use individual heat-shrink tubing to insulate the exposed leads to prevent accidental contact short-circuit (Fig.2)



3. Use stand-offs (Fig.3) or spacers (Fig.4) to securely position the LED above the PCB.

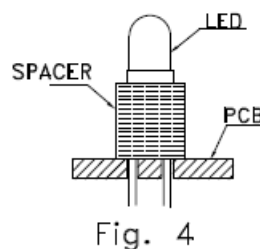
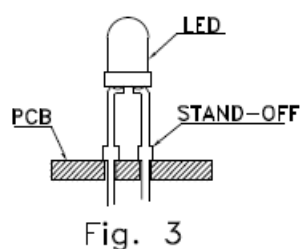

LEAD FORMING PROCEDURES

1. Maintain a minimum of 2mm clearance between the base of the LED lens and the first lead bend (Fig.5 and Fig.6).

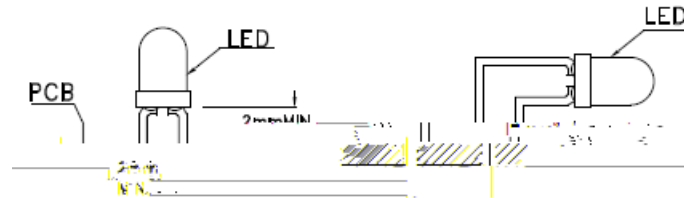

Fig. 6

Fig. 5

2. Lead forming or bending must be performed before soldering, never during or after soldering.

3. Do not stress the LED lens during lead-forming in order to fractures in the lens epoxy and damage the internal structures.

4. During lead forming, use tools or jigs to hold the leads securely so that the bending force will not be transmitted to the LED lens and its internal structures. Do not perform lead forming once the component has been mounted onto the PCB (Fig.7).

5. Do not bend the leads more than twice(Fig.8)

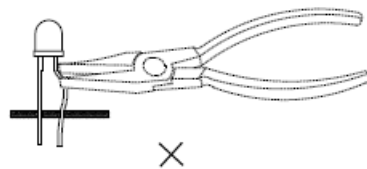

Fig. 7

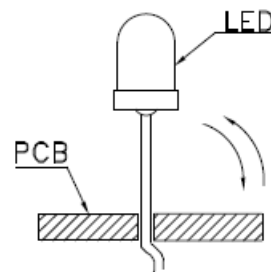

Fig. 8

6. After soldering or other high-temperature assembly, allow the LED to cool down to 50 before applying force (Fig.9).In general, avoid placing excess force on the LED to avoid damage. For any questions please consult with LIGHT representative for proper handling procedures.

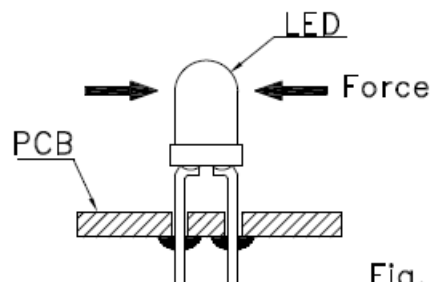

Fig. 9

